

CLIMATE CHANGE

08/2019

Economic models for assessing the economic effects of linking emissions trading schemes

CLIMATE CHANGE 08/2019

Environmental Research of the
Federal Ministry for the
Environment, Nature Conservation
and Nuclear Safety

Project No. (FKZ): 3714 41 505 0
UBA-FB 002599/ANH, ENG

Economic models for assessing the economic effects of linking emissions trading schemes

As part of the project “Analysis of Risks and Opportunities of Linking Emissions Trading Systems”

by

Julia Bingler, Dorothea Hauptstock, Johannes Thema, Christiane Beuermann
Wuppertal Institut für Klima, Umwelt, Energie gGmbH, Wuppertal

On behalf of the German Environment Agency

Imprint

Publisher:

Umweltbundesamt
Wörlitzer Platz 1
06844 Dessau-Roßlau
Tel: +49 340-2103-0
Fax: +49 340-2103-2285
info@umweltbundesamt.de
Internet: www.umweltbundesamt.de

 /umweltbundesamt.de

 /umweltbundesamt

Study performed by:

Wuppertal Institut für Klima, Umwelt, Energie gGmbH
Döppersberg 19
42103 Wuppertal

Study completed in:

February 2018

Edited by:

Section V 3.3 Economic Aspects of Emissions Trading, Monitoring, Evaluation
Claudia Gibis

Publication as pdf:

<http://www.umweltbundesamt.de/publikationen>

ISSN 1862-4359

Dessau-Roßlau, März 2019

The responsibility for the content of this publication lies with the author(s).

Abstract

The objective of this paper is to review approaches for a quantitative analysis of economic effects from bilateral linking of Emission Trading Systems. To this end, economic models that were principally deemed suitable for analysing these economic effects have been reviewed. The review is based on a number of specific criteria: the model type, the time horizon of the model and agents, the coverage of regions, economic activities, sectors and greenhouse gases as well as the possibility of sectoral disaggregation. The assessment shows that the five most suitable models are E3ME, GEM-E3, PACE, POLES and TIMES. The results for these models are provided in detail in the model discussion part of the paper.

Kurzbeschreibung

Ziel dieses Beitrags ist die Untersuchung von Ansätzen für eine quantitative Analyse ökonomischer Effekte aus der bilateralen Verknüpfung von Emissionshandelssystemen. Zu diesem Zweck wurden verschiedene ökonomische Modelle, die für die Analyse dieser wirtschaftlichen Effekte grundsätzlich als geeignet erachtet wurden, untersucht. Die Überprüfung basiert auf einer Reihe spezifischer Kriterien: dem Modelltyp, dem Zeithorizont des Modells und der Akteure, der Abdeckung von Regionen, wirtschaftlichen Aktivitäten, Sektoren und Treibhausgasen sowie der Möglichkeit einer sektoralen Disaggregation. Die Bewertung zeigt, dass die fünf am besten geeigneten Modelle E3ME, GEM-E3, PACE, POLES und TIMES sind. Die Ergebnisse für diese Modelle werden in einem Abschnitt ausführlich diskutiert.

Table of Contents

List of Figures.....	7
List of Tables.....	8
List of Abbreviations.....	9
Summary.....	10
Zusammenfassung.....	13
1 Introduction.....	17
2 Economic assessment criteria and indicators for estimating the effects of linking ETS.....	18
3 Model families.....	20
3.1 Modelling approaches.....	21
a) Optimisation models.....	21
b) Macro-econometric models.....	21
3.2 Model types: Top-down vs. bottom-up.....	22
a) Partial equilibrium models (PE): Technology-specific bottom-up approach.....	22
b) (Computable) General equilibrium models (CGE): Top-down approach.....	22
3.3 Optimisation models: Time horizon of the agents.....	23
a) Myopic optimisation.....	23
b) Perfect foresight (rational expectations).....	23
c) Limited/imperfect foresight.....	23
4 Specific model requirements for assessing the economic effects of linking ETS.....	24
4.1 Coverage and level of detail.....	24
a) Economic fields.....	24
b) Economic sectors.....	24
c) Regions.....	25
d) Time horizon of the model.....	25
e) Coverage of ETS-gases.....	26
f) Required model output.....	27
4.2 Summary of general model requirements.....	27
4.3 Preliminary evaluation of economic models with regard to their suitability to assess economic effects of linking ETS.....	28
a) Coverage of relevant linking criteria and indicators.....	28
b) Selection of most suitable models.....	29
5 Model description.....	31
5.1 E3ME.....	32
5.2 GEM-E3.....	38

5.3	PACE	42
5.4	POLES.....	47
5.5	TIMES.....	51
5.6	Overview-table over the fulfilment of criteria by model	55
6	Bibliography.....	56

List of Figures

Figure 1: Model families – main differences	20
Figure 2: Regional, national, and sub-national ETS: Coverage of aggregated sectors	25
Figure 3: Overview on how assessment criteria for linking ETS and regions are covered in existing models	30
Figure 4: E3ME model structure as an E3 model without additional modules	36
Figure 5: E3ME model structure as an E3 model with additional modules	37
Figure 6: PACE model structure	46
Figure 7: POLES model structure	50
Figure 8: TIMES model structure	55

List of Tables

Table 1: Economic Objectives of Linking, Assessment Criteria and Indicators	10
Table 2: Summary of general model requirements for assessing economic effects of linking ETS.....	12
Table 3: Economic Objectives of Linking, Assessment Criteria and Indicators	18
Table 4: Summary of general model requirements for assessing economic effects of linking ETS.....	27
Table 5: Summary E3ME.....	32
Table 6: Summary GEM-E3.....	38
Table 7: Summary PACE.....	42
Table 8: Summary POLES.....	47
Table 9: Summary TIMES.....	51
Table 10: Overview over the fulfilment of criteria by model	55

List of Abbreviations

AEEI	Autonomous Energy Efficiency Improvement
CCS	Carbon Capture and Storage
CES	Constant Elasticity of Substitution
CGE	Computable General Equilibrium
ETS	Emission Trading System
EU	European Union
GDP	Gross Domestic Product
GHG	Greenhouse Gases
GTAP	Global Trade Analysis Project
LULUCF	Land Use, Land Use Change and Forestry
MACC	Marginal Abatement Cost Curve
PE	Partial Equilibrium

Summary

The objective of this paper is to review existing economic models regarding their potential application for a quantitative assessment of the economic effects of linking Emission Trading Systems (ETS). As a matter of fact, most of the economic assessment criteria to evaluate the effects of a bilateral linking of ETS cannot be measured empirically, but need to be modelled by aid of economic modelling. The various models that are available in the market have been developed over the past years and decades, with partly very different economic foci and level of detail. This paper examines different modelling approaches to ETS on selected economic aspects.

Chapter 2 discusses the economic assessment criteria and related indicators for evaluating the impact of linking on economic objectives. Decision makers can have a number of reasons and expectations when considering linking. Regarding economic rationales, the three economic objectives which are analysed here are: (i) static efficiency/ reduction of mitigation cost, (ii) reduction of competitive distortions and (iii) increase of market stability/market liquidity. As these economic objectives are of a very general nature and usually not directly observable, more specific assessment criteria have been developed for evaluating the impact of linking on economic objectives. For measuring these assessment criteria, a measurable proxy indicator for each criterion has been defined. As a result, a table of three objectives split up into four criteria and described by thirteen indicators has been developed as a first requirement to economic models:

Table 1: Economic Objectives of Linking, Assessment Criteria and Indicators

Economic Objective	Criteria	Indicators	Quantification
Reduce mitigation costs	Mitigation costs (short-term, static)	Expected change [decrease] of carbon price (before and after linking)	Economic modelling
		Expected change [increase] in economy-wide production (GDP)	Economic modelling
Reduce competitive distortions	Competitiveness in relation to linking partner	[High] trade exposure of ETS sectors in relation to linking partner	Empirical quantitative data or economic modelling for future expected trade exposure ETS sectors after linking
		[Significant] differences in free allocation methods	Empirical qualitative data

Economic Objective	Criteria	Indicators	Quantification
Reduce competitive distortions (cont.)	Competitiveness in relation to linking partner (cont.)	[Significant] difference of carbon price level before linking	Empirical quantitative data
		[Large] net capital flows (from buyer to seller)	Economic modelling
	Competitiveness in relation to third Countries	[High] trade exposure of ETS sectors in relation to similar sectors in all third countries together	Empirical quantitative data or economic modelling for future expected trade exposure
		[Significant] expected relocation of production and investment (after linking)	Economic modelling
		Expected change [increase] of carbon price (before and after linking)	Economic modelling
		[Large] net capital flows	Economic modelling
5. Increase market stability	Market liquidity and stability	[Large] number of market participants (before and after linking) relative to market size and number of trades	Economic modelling or second best: empirical quantitative data
		Stable permit price (before linking)	Empirical quantitative data
		Availability and compatibility of safeguards against oversupply	Empirical qualitative data

Chapter 3 highlights the main differences between existing economic model families. In doing so it looks into the macroeconomic frameworks, the model potential to evaluate short- and long-run effects, to reflect technological constraints and to allow for technological progress. The review distinguishes optimisation models and econometric models. Both can either be of bottom-up or top-down type. Regarding optimisation models, these two main types correspond to the two main classes: Partial equilibrium models (PE models) and General equilibrium models (CGE models). Further, the optimisation models differ in their underlying optimisation principles. For each of the model families, types and time horizon, a concluding section discusses their pros and cons regarding their application to linking ETS.

Chapter 4 outlines the overall model specification requirements for assessing the economic effects of linking ETS as terms of references for the modellers. It concludes with a table summarising the general model requirements:

Table 2: Summary of general model requirements for assessing economic effects of linking ETS

Model	Requirement
Type	Ideally CGE with bottom-up PE-elements in the energy sector + ideally in the industry sector; and ideally many econometrically estimated parameters
Time horizon of the agents	Ideally limited foresight optimisation
Time horizon of the model	Short- (less than 5 years) and long term (more than 10 years, ideally more than 35 years) (until 2020 annual steps, end date around 2050)
Economic fields	Domestic economy, international trade, linked permit market
Sectors	All ETS-sectors (energy, industry, domestic and partly international aviation for EU-ETS) + rest of the economy
Regions	EU-ETS31 + potential linking partners (e.g. China, South Korea, Mexico, Turkey) + Rest of the world (ROW)
Emissions	All ETS-gases from all ETS-sectors at disaggregated level (CO ₂ , N ₂ O, PFCs; from fossil fuel combustion and processes for a symmetric link of the EU-ETS)
Sectoral disaggregation	Disaggregation should be detailed enough to provide meaningful results, depending on the selected assessment criteria. When, for example, sectoral competitiveness-effects are to be assessed, a single-industry-sector model does not provide the information required (cf. Alexeeva-Talebi et al. 2012).

In Chapter 5, the overall model requirements are mapped onto the gathered list of models. None of the models perfectly fulfils the requirements. Some models perform better in terms of regional coverage, some perform better in terms of criteria coverage, some provide a compromise with good but not optimal regional and criteria coverage at the same time.

Five models have been identified as most suitable for the assessment of economic effects of linking ETS. These are:

- ▶ E3ME (Macro-econometric model)
- ▶ GEM-E3 (general equilibrium model)
- ▶ PACE (general equilibrium model)
- ▶ POLES (partial equilibrium model)
- ▶ TIMES-MARKAL (partial equilibrium model)

The results of the assessment for each model are presented in detail in subchapters. As a conclusion, only two models are useful as stand-alone models for analysing linking effects: **E3ME** with the most useful combined regional and criteria coverage and high sectoral disaggregation and **PACE** with generally good criteria coverage and flexible regional coverage, however, depending on available data. The three remaining models **POLES** (good regional coverage, detailed permit market module), **TIMES-MARKAL** (very flexible) and **GEM-E3** (most useful criteria coverage, limited regional coverage) have some limitations. Nevertheless, they seem to be very useful to complement the stand-alone models in the analysis, since they fulfill some requirements that E3ME or PACE do not fulfill at all or not as detailed as required.

Zusammenfassung

Ziel dieses Papiers ist es, existierende ökonomische Modelle hinsichtlich ihrer möglichen Anwendung für eine quantitative Bewertung der wirtschaftlichen Auswirkungen der Verknüpfung von Emissionshandelssystemen (ETS) zu untersuchen. In der Tat können die meisten wirtschaftlichen Bewertungskriterien zur Abschätzung der Auswirkungen eines bilateralen Linkings von ETS nicht empirisch gemessen werden, sondern müssen mit Hilfe von ökonomischen Modellen modelliert werden. Die verschiedenen Modelle, die auf dem Markt verfügbar sind, wurden in den letzten Jahren und Jahrzehnten entwickelt, mit teilweise sehr unterschiedlichen wirtschaftlichen Schwerpunkten und Detaillierungsgraden. Der vorliegende Bericht untersucht verschiedene Ansätze zur Modellierung des ETS mit ausgewählten ökonomischen Aspekten.

In Kapitel 2 werden die ökonomischen Bewertungskriterien und die damit verbundenen Indikatoren zur Bewertung der Auswirkungen eines Linkings auf wirtschaftliche Ziele erörtert. Entscheidungsträger können eine Reihe von Gründen und Erwartungen haben, wenn sie ein Linking in Betracht ziehen. Im Kontext der wirtschaftlichen Gründe werden in diesem Bericht drei ökonomische Ziele analysiert: (i) statische Effizienz / Verringerung der Minderungskosten, (ii) Verringerung von Wettbewerbsverzerrungen und (iii) Erhöhung der Marktstabilität / Marktliquidität. Da diese wirtschaftlichen Ziele sehr allgemeiner Art sind und in der Regel nicht direkt beobachtbar sind, wurden spezifischere Bewertungskriterien entwickelt, um die Auswirkungen eines Linkings auf wirtschaftliche Ziele zu bewerten. Zur Operationalisierung dieser Bewertungskriterien wurde ein messbarer Proxy-Indikator für jedes Kriterium definiert. Im Ergebnis wurde eine Tabelle als erste Anforderung an ökonomische Modelle entwickelt, die drei ökonomische Ziele und vier Kriterien unterscheidet, die mit 13 Indikatoren beschrieben werden können:

Tabelle 1: Ökonomische Ziele von Linking, Bewertungskriterien und Indikatoren

Ökonomische Ziele	Kriterien	Indikatoren	Quantifizierung
Verringerung der Minderungskosten	Minderungskosten (kurzfristig, statisch)	Erwartete Änderung [Senkung] des CO ₂ -Preises (vor und nach dem Linking)	Ökonomische Modellierung
		Erwartete Änderung [Steigerung] der gesamtwirtschaftlichen Produktion (BIP)	Ökonomische Modellierung
Verringerung von Wettbewerbsverzerrungen	Wettbewerbsfähigkeit im Verhältnis zum Linking-Partner	[Hohe] Handelsintensität der ETS Sektoren im Verhältnis zum Linking-Partner	Empirische quantitative Daten oder ökonomische Modellierung der künftig erwarteten Handelsintensität nach einem Linking
		[Erhebliche] Unterschiede in den Methoden der kostenlosen Zuteilung	Empirische qualitative Daten

Ökonomische Ziele	Kriterien	Indikatoren	Quantifizierung
Verringerung von Wettbewerbsverzerrungen (Fortsetzung)	Wettbewerbsfähigkeit im Verhältnis zum Linking-Partner (Fortsetzung)	[Erhebliche] Unterschiede im Niveau des CO ₂ -Preises vor einem Linking	Empirische quantitative Daten
		[Große] Netto Kapitalflüsse (vom Käufer zum Verkäufer)	Ökonomische Modellierung
	Wettbewerbsfähigkeit im Verhältnis zu Drittländern	[High] [Hohe] Handelsintensität der ETS Sektoren im Verhältnis zu Drittländern	Empirische quantitative Daten oder ökonomische Modellierung der künftig erwarteten Handelsintensität nach einem Linking
		[Erhebliche] erwartete Produktions- und Investitionsverlagerungen (nach einem Linking)	Ökonomische Modellierung
		Erwartete Änderung [Steigerung] des CO ₂ -Preises (vor und nach einem Linking)	Ökonomische Modellierung
Erhöhung der Marktstabilität	Marktstabilität / Marktliquidität	[Große] Netto-Kapitalflüsse	Ökonomische Modellierung
		[Große] Zahl der Marktteilnehmer (vor und nach dem Linking) im Verhältnis zur Marktgröße und zur Zahl der Handelstransaktionen	Ökonomische Modellierung oder alternativ: empirische quantitative Daten
		Stabiler CO ₂ -Preis (vor dem Linking)	Empirische quantitative Daten
		Existenz und Kompatibilität von Sicherheitsvorkehrungen gegen Überschüsse	Empirische quantitative Daten

In Kapitel 3 werden die Hauptunterschiede zwischen den bestehenden ökonomischen Modellfamilien erläutert. Dabei werden die makroökonomischen Rahmenbedingungen sowie das Potenzial der Modelle zur Bewertung kurz- und langfristiger Auswirkungen, zur Berücksichtigung technologischer Restriktionen und des technologischen Fortschritts untersucht. Unterschieden wird zwischen Optimierungsmodellen und ökonometrischen Modellen. Beide können entweder vom Typ Bottom-up oder Top-down sein. Bei den Optimierungsmodellen entsprechen diese beiden Haupttypen den beiden Hauptklassen: Partielle Gleichgewichtsmodelle (PE-Modelle) und Allgemeine Gleichgewichtsmodelle (CGE-Modelle). Darüber hinaus unterscheiden sich die Optimierungsmodelle in ihren zugrundeliegenden Optimierungsprinzipien. Für jede der Modellfamilien, Modelltypen und Zeithorizonte werden in

einem abschließenden Abschnitt Vor- und Nachteile in Bezug auf ihre Nutzung zur Untersuchung eines Linkings von ETS diskutiert.

In Kapitel 4 werden die allgemeinen Modellspezifikationen für die Bewertung der wirtschaftlichen Auswirkungen eines Linkings von ETS als Referenzbedingungen für die Modellierer beschrieben. Die allgemeinen Modellanforderungen sind in einer Tabelle zusammengefasst:

Tabelle 2: Zusammenfassung der allgemeinen Modellanforderungen für eine Bewertung der ökonomischen Effekte eines Linkings von Emissionshandelssystemen

Modell	Anforderung
Typ	Idealerweise allgemeines Gleichgewichts-(CGE-)Modell mit Elementen eines bottom-up Partialmodells für den Energie- und idealerweise für den Industriesektor; außerdem idealerweise viele ökonometrisch geschätzte Parameter
Zeithorizont der Akteure	Idealerweise Optimierung mit begrenzter Voraussicht
Zeithorizont des Modells	kurzfristig (weniger als 5 Jahre) und langfristig (mehr als 10 Jahre, idealerweise mehr als 35 Jahre) (jährliche Schritte bis 2020, Enddatum ca. 2050)
Ökonomische Bereiche	Inländische Volkswirtschaft, internationaler Handel, verknüpfter Markt für Emissionsberechtigungen
Sektoren	Alle ETS-Sektoren (Energie, Industrie, inländischer und teilweise internationaler Luftverkehr) + Rest der Wirtschaft
Regionen	EU-ETS31 + potenzielle Linking-Partner (z.B. China, Südkorea, Mexiko, Türkei) + Rest der Welt (ROW)
Emissionen	Alle ETS-Treibhausgase in allen ETS-Sektoren auf disaggregierter Ebene (CO ₂ , N ₂ O, PFCs; aus Verbrennung und Prozessemissionen)
Sektorale Disaggregation	Disaggregation sollte für aussagekräftige Ergebnisse hinreichend detailliert sein, je nach ausgewähltem Bewertungskriterium. Bei der Bewertung von sektoralen Wettbewerbseffekten, wäre eine Modell, das den Industriesektor nur gesamt abbildet, nicht hinreichend (vgl. Alexeeva-Talebi et al. 2012).

In Kapitel 5 werden die allgemeinen Modellanforderungen mit der Liste der zu untersuchenden Modelle abgeglichen. Keines der Modelle erfüllt die Anforderungen perfekt. Einige Modelle schneiden in Bezug auf die regionale Abdeckung besser ab, andere besser in Bezug auf die Kriterienabdeckung, andere bieten einen Kompromiss mit einer guten, aber nicht optimalen regionalen und Kriterienabdeckung zur gleichen Zeit.

Fünf Modelle wurden als am besten geeignet für die Bewertung der wirtschaftlichen Auswirkungen eines ETS-Linkings identifiziert. Diese sind:

- ▶ E3ME (Makro-ökonometrisches Modell)
- ▶ GEM-E3 (allgemeines Gleichgewichtsmodell)
- ▶ PACE (allgemeines Gleichgewichtsmodell)
- ▶ POLES (allgemeines Gleichgewichtsmodell)
- ▶ TIMES-MARKAL (partiell Gleichgewichtsmodell)

Die Ergebnisse der Bewertung werden für jedes Modell detailliert in den jeweiligen Unterkapiteln dargestellt. Im Ergebnis sind nur zwei Modelle als eigenständige Modelle zur Analyse von Linking-Effek-

ten verwendbar: E3ME mit der am besten geeigneten Kombination aus regionaler und Kriterienabdeckung sowie einer hohen sektoraler Disaggregation und PACE mit generell guter Kriterienabdeckung und flexibler regionaler Abdeckung, je nach verfügbaren Daten. Die drei verbleibenden Modelle POLES (gute regionale Abdeckung, detailliertes Modul zum Markt für Emissionsberechtigungen), TIMES-MARKAL (sehr flexibel) und GEM-E3 (beste Kriterienabdeckung, begrenzte regionale Abdeckung) weisen einige Einschränkungen auf. Dennoch können sie sehr nützlich zu sein, um die Stand-Alone-Modelle in der Analyse zu ergänzen, da sie einige Anforderungen erfüllen, die E3ME oder PACE nicht oder nicht so genau erfüllen wie erforderlich.

1 Introduction

This report has been elaborated in the context of a research project funded by the German UFOPLAN (“Assessment of the effects of linking emissions trading systems”, FKZ: 714 41 505 0) and carried out by adelphi and Wuppertal Institut between 2014 and 2017.

The overall objective was to develop a systematic framework aiming at an assessment of a potential bilateral linking of emission trading systems (ETS) worldwide. The intention was to enable political decision-makers to identify chances and risks of potential future linking plans and to support them in their efforts to prepare linking initiatives. In doing so, an important part was to quantify the economic effects of linking as far as possible and to relate the result of these economic assessments to additional qualitative assessment criteria. For the quantification of effects, several existing economic models have been reviewed, for the qualitative assessment, in particular, several design elements of an ETS have been discussed as regards their relevance for a successful linking. The overall results of the research project have been systematically integrated in a manual for decision-makers „Considering the Effects of Linking Emissions Trading Schemes – A manual on Bilateral Linking of ETS” (Beuermann, Bingler, Santikarn, Tänzler, Thema 2017).

This paper focuses on the review of existing economic models regarding their potential application for a quantitative assessment of the effects of linking initiatives. As a matter of fact, most of the economic assessment criteria to evaluate the effects of a bilateral linking of ETS cannot be measured empirically, but need to be modelled by aid of economic modelling. The various models that are available in the market have been developed over the past years and decades, with partly very different economic foci and level of detail. This paper examines different modelling approaches to quantify the impact of linking Emission Trading Schemes (ETS) on those selected economic assessment criteria that cannot be measured with empirical data. The aim is to give a comprehensive overview on selected economic models suitable for assessing the economic effects of linking. To this end, eleven economic models that were principally deemed suitable for analysing the economic effects of linking have been assessed: six CGE models (Aim-CGE, EPPA(-EU), GEM-E3, G-cubed, IMACLIM-R and PACE), one macro-econometric model (E3ME) and four PE models (POLES, PRIMES, REMIND-R, TIMES-M.). Five models will be described in more detail in this report (E3ME, GEM-E3, PACE, POLES, TIMES).

Chapter 2 discusses the economic assessment criteria and related indicators. Chapter 3 highlights the main differences between existing economic model families. Chapter 4 outlines the overall model requirements for assessing the economic effects of linking ETS as terms of references for the modellers. In Chapter 5, different models will be described with emphasis on each model’s pros and cons for the assessment of the impacts of linking on selected economic assessment criteria.

2 Economic assessment criteria and indicators for estimating the effects of linking ETS

Decision makers can have a number of reasons and expectations when considering linking. Apart from economic rationales, environmental and political objectives play a major role as empirical observations suggest. The research project in the context of which this report was elaborated defined seven environmental, economic and political objectives¹.

The three economic objectives which are analysed are:

- ▶ static efficiency/ reduction of mitigation cost,
- ▶ reduction of competitive distortions and
- ▶ increase of market stability/market liquidity.

They are of a very general nature and usually not directly observable. Therefore, more specific assessment criteria are needed for evaluating the impact of linking on economic objectives. For measuring the assessment criteria, they need to be operationalised, i.e. a measurable proxy for the criterion (indicator) has to be defined (see Table 3)². The way how the proxy is then measured depends on the available data for quantification. Most economic criteria cannot be measured empirically, but require economic modelling, especially for an ex-ante assessment before linking.

Table 3: Economic Objectives of Linking, Assessment Criteria and Indicators

Economic Objective	Criteria	Indicators	Quantification
Reduce mitigation costs	Mitigation costs (short-term, static)	Expected change [decrease] of carbon price (before and after linking)	Economic modelling
		Expected change [increase] in economy-wide production (GDP)	Economic modelling

¹ The analytical framework of this report is based upon the results of a research project funded by the Federal Environment Agency (FKZ 714 41 505 0). For more information, for instance on the definition of objectives and indicators see Beuermann, Bingler, Santikarn, Tänzler, Thema (2017).

² The correlations between assessing the effects of linking, the selected objectives and the identified assessment criteria are explained in detail in Beuermann, Bingler, Santikarn, Tänzler, Thema (2017).

Economic Objective	Criteria	Indicators	Quantification
Reduce competitive distortions	Competitiveness in relation to linking partner	[High] trade exposure of ETS sectors in relation to linking partner	Empirical quantitative data or economic modelling for future expected trade exposure ETS sectors after linking
		[Significant] differences in free allocation methods	Empirical qualitative data
		[Significant] difference of carbon price level before linking	Empirical quantitative data
	Competitiveness in relation to third Countries	[Large] net capital flows (from buyer to seller)	Economic modelling
		[High] trade exposure of ETS sectors in relation to similar sectors in all third countries together	Empirical quantitative data or economic modelling for future expected trade exposure
		[Significant] expected relocation of production and investment (after linking)	Economic modelling
		Expected change [increase] of carbon price (before and after linking)	Economic modelling
		[Large] net capital flows	Economic modelling
5. Increase market stability	Market liquidity and stability	[Large] number of market participants (before and after linking) relative to market size and number of trades	Economic modelling or second best: empirical quantitative data
		Stable permit price (before linking)	Empirical quantitative data
		Availability and compatibility of safeguards against oversupply	Empirical qualitative data

3 Model families

As has been shown in chapter 2, most of the economic assessment criteria cannot be measured empirically, but need economic modelling. Suitable models should not only fulfil concrete specification requirements (see chapter 4), but also be based on a consistent macroeconomic framework, evaluate short- and long-run effects, reflect technological constraints and allow for technological progress.

Generally, the use of economic modelling for political decision-making has its limitations: Regardless of how well a model is designed and set-up, modelling never replicates reality and always has shortcomings that have to be kept in mind when working with modelling output. To ensure computability, global models usually use highly aggregated data, which limits the validity and meaningfulness of results. Assumptions about learning curves, especially in low-carbon technologies, are very important in the context of linking, since they influence the permit price via the marginal abatement costs. These assumptions often lack behind the real figures, since updating and re-calibrating the models takes time and is costly. Therefore, modelled costs for low-carbon technologies (i.e. renewable energies and energy efficiency technologies) tend to be higher in models than in reality. Further, some models assume a widespread employment of technologies like Carbon Capture and Storage (CCS), nuclear energy and the large-scale use of biomass, which, due to their relatively high (perceived) risks and societal opposition, are in reality highly debated.

Models are designed to answer different questions, therefore model characteristics vary largely. There is a broad range of questions different economic models can be applied to (Hedenus et al. 2012, p.2).

In general, there are two main approaches to economic modelling: Optimisation models and econometric models (section 3.1). They can either be of bottom-up or top-down type (section 3.2). Within the group of optimisation models, these two main types correspond to the two main classes: Partial equilibrium models (PE models) and General equilibrium models (CGE models, section 3.2). Further, the optimisation models differ in their underlying optimisation principle (section 3.3). Figure 1 shows the differentiation in modelling approaches, modelling types and driving solution principle which represents the time horizons of the agents. All economic modelling approaches differ in the coverage of economic fields, sectors, regions, time horizons of the model and emission types, and in the level of detail for each of these aspects (section 4.1).

Figure 1: Model families – main differences

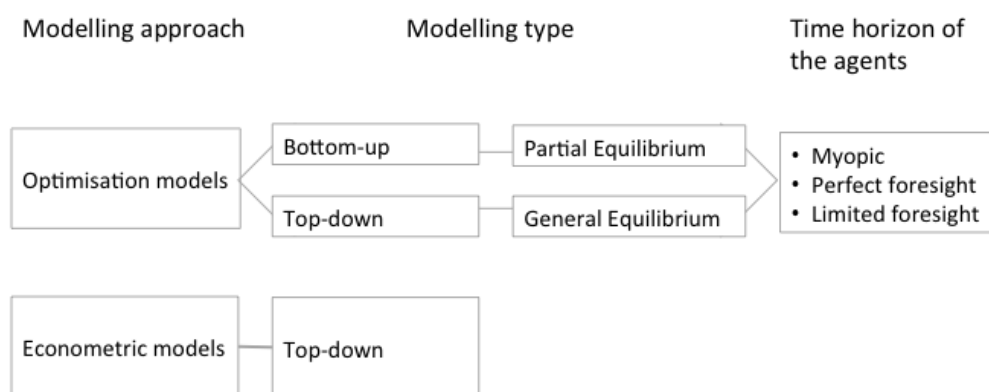

3.1 Modelling approaches

There are two main economic modelling approaches, which can principally be used for assessing the economic impacts of linking ETS: Optimisation- and econometric models. They differ in economic backgrounds, and especially in their treatment of behavioural relationships. Whilst optimisation models assume behaviour in line with economic optimisation theory, i.e. perfect knowledge or that markets are completely cleared, econometric models allow for the possibility of unused resources and sub-optimal behaviour (Cambridge Econometrics 2014, p.26).

a) Optimisation models

These models are based on the equilibrium principles of neoclassical economic theory. In order to find the equilibrium solution, theory-based models need to make assumptions about agents' behaviour and the basic driving principles of the economy (see section 3.3). Given these assumptions and general theoretical reasoning, the models' functions are defined. The modellers then calibrate the parameters of these functions to reflect empirical cases. Depending on the aim of the analysis, this calibration either reflects convenience (easily solvable functions), different values (to show the importance of parameters or to analyse differences of changes in parameters' values) or empirical estimates. Based on the functions, the system of equations is mathematically solved, finding the optimal solution under certain constraints.

The advantage of these models are the limited data requirements. Yet, some of these models' crucial assumptions to reduce complexity and data requirements³ are considered as not being realistic, for example the assumption of perfect competition. They might reduce complexity and reduce the required computational power to solve the model. Nevertheless, these assumptions might as well yield economically optimal, yet unrealistic results.

b) Macro-econometric models

These models are based on empirical data about past relationships between the variables of interest. When modelling macro-economic behaviour of a system, these models are usually based on input-output accounting. Instead of computing equilibrium solutions, they simulate flows of capital and other monetised quantities between different sectors. By aid of econometrically derived input-output coefficients, the model then shows the impact of these flows on different variables of interest, like economic output or investments. National indicators like Gross Domestic Product (GDP), labour markets and wages can be derived by aggregating sectoral values (Loulou et al. 2005, p.23).

The advantage of econometric models is that they do not rely on restrictive assumptions like rational agents and self-interested behaviour. Yet, a major disadvantage is the extensive need for comparable data across time and space. The more disaggregated the model, the more difficult it is to collect the necessary data.

Conclusion

Since it is quite difficult to collect internationally comparable input-output data that go far enough in the past to obtain meaningful coefficients and still have a rather high level of sectoral disaggregation, a suitable model for the present research purpose is a CGE model where at least some coefficients are

³ Crucial assumptions are assumptions where the model outcome changes with changes in the assumption.

econometrically estimated with time-series data, rather than just calibrated to a single base year (Capros et al. 2013, p.80f.).⁴ These models are sometimes referred to as hybrid models, when the share of estimated parameters is relatively high, compared to the calibrated parameters.

3.2 Model types: Top-down vs. bottom-up

Models differ between top-down versus technology-specific bottom-up approaches, which roughly corresponds to the dichotomy between partial- versus full market coverage. Macro-econometric models belong to the type of top-down models. Within the group of optimisation models, both approaches can be found (Hedenus et al. 2012, p.5f.):

a) Partial equilibrium models (PE): Technology-specific bottom-up approach

These models estimate the effects of changes, i.e. in energy prices, on changes in partial areas of the economy, i.e. the energy system. The limited sectoral scope of these models allows for a detailed coverage of e.g. different energy-consuming technologies. The representative agent chooses amongst a set of represented technologies the profit- or utility-maximising production technology⁵. Linking inputs and outputs of the bottom-up technology-choices yields the overall market outcome. Thus, in contrast to pre-defined production functions in the top-down approach, production functions and marginal abatement cost curves are implicitly constructed in the bottom-up approach (Loulou et al. 2005, p.21). A major limitation of using these models for the present research purpose (i.e. to assess mitigation costs) is that overall economic indicators like GDP are usually exogenous model inputs.

b) (Computable) General equilibrium models (CGE): Top-down approach

These models estimate the effects of changes in some parts of the economy (e.g. in energy prices) on all sectors and general welfare, by aid of aggregated functions and values. Instead of a detailed technological representation, the top-down approach uses pre-defined production functions and marginal abatement cost curves. The production function simulates the potential substitutability between the production factors, which are themselves usually highly aggregated (such as “labour”, “energy”, “capital”). Function parameters are calibrated either with bottom-up model results, or using empirical data (Hedenus et al. 2012, p.5; Loulou et al. 2005, p.20f.). A disadvantage to use these models for the present purpose is the usage of pre-defined production functions and the resulting lack of a detailed and empirically grounded technology representation in each sector, which might yield significantly different results regarding competitiveness and leakage effects (Alexeeva-Talebi et al. 2012).

Conclusion

Albeit both, CGE and PE models, use optimisation techniques, PE models usually pursue a welfare-maximising approach, and CGE models a cost-minimising strategy. This is due to the fact that PE models usually calculate the production, consumption and prices of commodities simultaneously (Loulou et al. 2005, p.20). In order to limit complexity, most CGE models use exogenously given demand in commodities to determine the respective prices; or vice-versa.

⁴ Capros et al. 2013, p.80f. provide a useful overview over the pros and cons regarding parameter calibration versus estimation.

⁵ Besides PE models, simulation models represent another type of technology-specific models. Here, agents do not only focus on profit-maximisation when taking decisions. As such, investments in technologies with higher life-cycle costs than other technologies become possible (Loulou et al. 2005, p.23). However, the present report focuses on PE and CGE models, since simulation models are not as well developed as the other types, yet. They do not consider the complex interactions of economic variables, which are required for quantifying the economic assessment criteria for the present analysis.

Recently, modellers increasingly combine the advantages of PE and CGE approaches in so-called hybrid models. Several top-down models represent an increasingly differentiated energy sector, which is very useful to get a broad and realistic impression of the effects of linking on economic assessment criteria. Some bottom-up models start to include effects of energy system changes on the entire economy, like changes in end-use demand, or are linked to macroeconomic models (for example linking TIMES with MACRO, cf. Remme & Blesl 2006).

3.3 Optimisation models: Time horizon of the agents

The following section applies only to optimisation models and is not relevant for econometric approaches. By solving a set of pre-defined equations under certain constraints, optimisation models try to find either the welfare maximising solution (usually in partial equilibrium models), or the cost minimising solution (usually in CGE models). There are three main time-dynamic approaches to do the optimisation which represent the time horizons of the agents (Hedenus et al. 2012, p.4f.):

a) Myopic optimisation

The optimisation is done at each point in time without knowing or by ignoring the state of the future system. It is mostly suitable to analyse reactions to certain policy measures by myopic agents, i.e. in the financial sector when short-term profits guide agents' decisions.

b) Perfect foresight (rational expectations)

The optimisation is done under full consideration of all future states of the system (prices, constraints etc.). This approach is mostly used to find the optimal solution from the policy planner's point of view, i.e. to find the cost-efficient technology mix to reach a certain emission reduction goal.

c) Limited/imperfect foresight

The optimisation is done under perfect foresight for a limited period of time without knowing the state of the future system beyond the considered period. This approach is used to model a rather realistic behaviour of economic agents and impacts of non-optimal decisions in a rather inflexible world due to behavioural routines or inertias in the capital stock in the short-run (Waisman et al. 2010, p.2f.). For example, the assumption is useful when modelling production- and investment decisions to a newly introduced policy, which are based on medium-run considerations that go beyond myopic decisions but where knowledge about the future states of the world is limited.

Conclusion

For the purpose of identifying suitable models that fulfil concrete specification requirements for evaluating economic effects of a potential linking of ETS, limited foresight seems to be the most appropriate approach. Perfect foresight would probably yield results of limited reliability, since with market-based instruments like ETS, decisions of many decentralised and heterogeneous market participants add up to a certain outcome. These individually optimal decisions do usually not correspond to the welfare-maximising solution of the farsighted social planner (especially not when dynamic efficiency is taken into account). At the same time, these market participants usually remain in the market over a longer period, implying that they do not take decisions in a completely myopic way. It is rather likely that market participants take the near future into consideration when making decisions, which means that limited foresight should be favoured when choosing amongst different suitable models.

4 Specific model requirements for assessing the economic effects of linking ETS

For assessing the economic effects of linking ETS models should fulfil concrete specification requirements regarding coverage and the level of detail and be able to quantify the assessment criteria and indicators. The assessment whether a model is suitable for evaluating economic linking effects depends on to which extent a model fulfils the requirements outlined in the following sections.

4.1 Coverage and level of detail

Models differ in the coverage and level of detail in different aspects. For the present analysis, the coverage of spheres of the economy, sectors, regions, time horizons and greenhouse gases (GHG) is relevant for the model selection. This section describes briefly the general requirements suitable models should fulfil for the present purpose.

a) Economic fields

For this report, models have been assessed with regard to their capability to quantify linking-induced changes of mitigation costs in the ETS-sectors and the entire economy, competitiveness and carbon leakage in relation to the linking partner and third countries, and market liquidity, compared to a baseline scenario where already existing ETS are not linked. Therefore, a models' scope should cover the relevant fields of the economy, i.e. the domestic economy (in order to analyse mitigation costs), international trade (in order to analyse carbon leakage and competitiveness) and the permit market (in order to analyse market liquidity).

b) Economic sectors

Every model quantifying the effects of a symmetric linking ETS on different economic indicators needs to cover at least all sectors that are covered by the ETS. For the EU-ETS, this means that the industrial sector and the energy sector need to be included.⁶ For asymmetric linking, all sectors of the partner ETS need to be included, too. For an overview over which sectors are recently covered by ETS respectively, see Figure 2. For the models considered in the report, it is assumed that the EU-ETS pursues a symmetric link, focussing on the energy- and industry sector. With regard to the linking partners, some ETS schemes cover more sectors than the EU-ETS or do not cover both, electricity and industry. However, for simplicity, for the following assessment and selection of suitable models it is assumed that a symmetric link between the EU-ETS and the potential linking partner can be established.

Further, since changes in one sector might affect other sectors as well, a complete sectoral coverage or at least endogenous overall economic production is necessary for assessing economy-wide abatement costs.

The required level of sectoral disaggregation depends on the specific assessment criterion. If for example the change in sectoral abatement costs due to linking ETS is to be analysed, the level of sectoral disaggregation does not have to be as detailed as when analysing competitiveness and carbon leakage, which can be very different in specific sub-sectors (Alexeeva-Talebi et al. 2012).

⁶ Aviation is generally not considered as the EU ETS considers only a small part (Intra EU) but not international aviation.

Figure 2: Regional, national, and sub-national ETS: Coverage of aggregated sectors

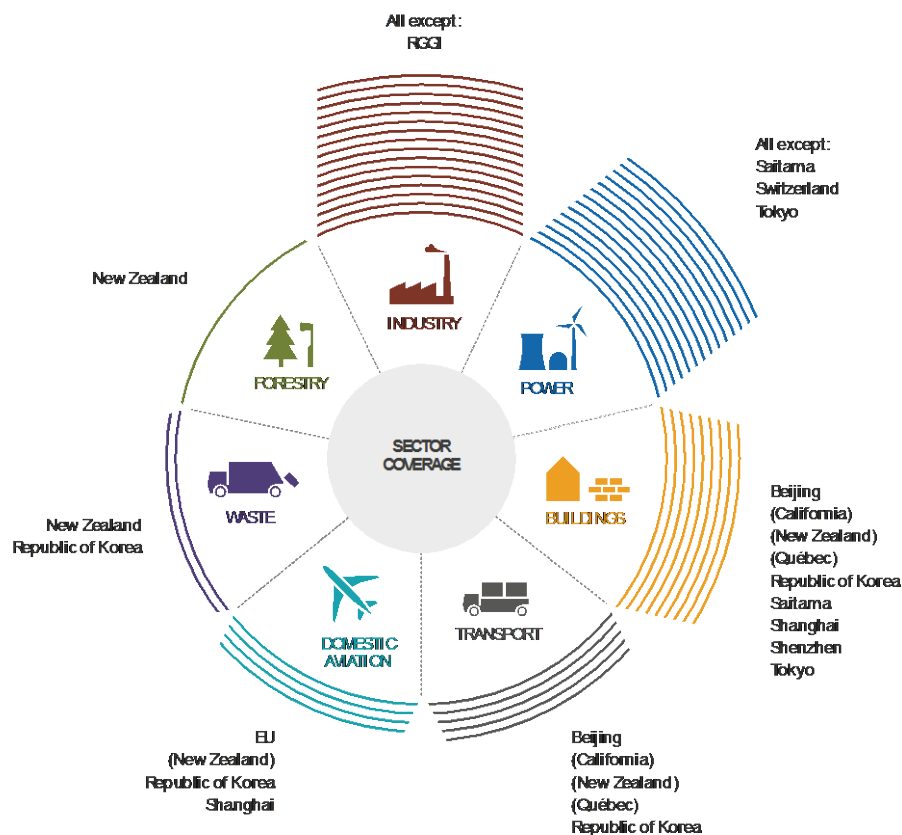

ICAP 2016, p.26

c) Regions

Obviously, a suitable model has to cover the jurisdictional boundaries of the different ETS whose linkage is to be simulated. For the EU-ETS, these are the EU-28 + Liechtenstein, Iceland and Norway. Further, it should cover potential linking partners.

For the present analysis China, South Korea, Mexico and Turkey have been selected for illustration purposes, as they are major economies having established already or considering implementing an ETS and could therefore be potential candidates for a linking.

To analyse carbon leakage with respect to third countries or the rest of the world, the respective countries should be included, too. Further, when changes in domestic abatement due to linked ETS affect trade patterns, trade with the rest of the world needs to be included in order to assess subordinate effects of changes in mitigation costs resulting from trade.

d) Time horizon of the model

The definition of a suitable time horizon of the analysis is important for selecting a suitable model. The model should cover at least the clearly defined trading periods (which is the year 2020 for the EU-ETS). From the current perspective, this is a short-run time horizon (less than 5 years). Short-term

economic effects of linking will have an impact on the political acceptability of the policy measure and are hence an important aspect in the linking decision. At the same time, in order to estimate overall policy costs, the performance of the system needs to be evaluated over a longer period (more than 10 years). It is useful to evaluate a time frame that goes significantly beyond 10 years, since the capital turnover cycle in the energy market is around 35 years. As such, replacement investments in low-carbon technology at the end of the “natural” replacement cycle would significantly reduce overall compliance costs (Hedenus et al. 2012, p.3).

The existing energy system is likely to remain largely the same in the short run due to long investment planning and operation cycles. This means that technological change takes its time to translate into changes in the carbon price. Facing a trade-off between technological level of detail (mostly PE models) and broad coverage of sectors at a level disaggregated enough for a meaningful analysis with endogenous GDP (mostly CGE and econometric models), one should favour a disaggregated sectoral coverage. The latter models have the further advantages that they take interaction and interdependences between all sectors into account (i.e. interdependences in production and MACC between ETS- and non-ETS-sectors) CGE models and econometric models are hence very useful to analyse short-term effects of linking when technologies do not change significantly (Hedenus et al. 2012, p.2). However, if partial effects or technological details are of interest, CGE modelling might be complemented with PE models, for example in a case where dynamic changes in technologies such as an increased share of renewable energies would be not covered in an CGE.

Yet, in the long-run, the foundations of the energy system will likely change due to a replacement of investments, introduction of new technologies etc. Further, a policy measure might induce changes in the entire economic structure. Here, technology-specific PE models are less useful, since they rely on pre-selected specific technologies and focus only on one sector. CGE models in contrast simulate the influence of changes in one sector on the performance of other sectors, which drives changes in the overall economic structure. Further, they allow for abstract technological change, which induces changes in the economic structure, too, without having to specify parameters for technologies that are not invented yet and might be beyond the modellers’ imagination.

Hence, both model types might be useful for the present purpose. Alternatively, hybrid models can be used to capture both, the short- and the long-run time horizon (Hedenus et al. 2012, p.3).

e) Coverage of ETS-gases

The model should include all GHG covered by the respective ETS. This can become quite complex in practice. The following questions need to be answered before assessing the fitness of a model to cover all GHG gases included in the ETS:

- ▶ Are all ETS-gases covered?
- ▶ Are all sources of these ETS-gases covered (e.g. fossil fuel combustion, process emissions, waste, land use and land use change etc.)?
- ▶ Are these emissions reported at a sufficiently disaggregated level (e.g. not only at the regional level, better ETS vs. non-ETS or by sector)?

The EU-ETS covers CO₂, N₂O (from the production of certain acids) and PFC (from aluminium production) emissions. This means that these emissions from burning fossil-fuels in energy generation, industry processes and aviation need to be reported. However, it might be difficult to obtain the specific N₂O emissions from the production of certain acids and the specific PFC emissions from aluminium production, since models usually do not report these emissions in such a level of disaggregation (the aluminium sector for example is in most models not reported explicitly, hence its emissions are not disaggregated, either). As economic models have to reduce complexity, different GHG gases and their specific sources and characteristics can only be covered to some extent. In the present analysis, the emission

coverage requirement will be regarded as adequately fulfilled if at least CO₂ emissions from fossil fuel combustion and production processes are reported at the sectoral level.

When analysing asymmetric links of the EU-ETS, the required coverage of GHG emissions might include as well GHG emissions from other sources, for example LULUC (land use and land use change). This means that the CO₂ emissions should reflect these emissions, too. Further, GHG emissions other than CO₂, N₂O and PFCs, such as CH₄, have to be simulated as well, if they are covered in the linked ETS.

f) Required model output

An assessment of the economic effects of linking ETS requires that some relevant economic indicators are quantified by aid of economic modelling (as listed in Table 1). Thus, models have to provide the following (endogenous) output data:

- ▶ Endogenous permit price for all ETS-sectors in linked markets
- ▶ Endogenous production (i.e. GVA) by ETS-sector by region
- ▶ Endogenous overall production (i.e. GDP) by region
- ▶ Endogenous investments by ETS-sector by region
- ▶ Endogenous exports by ETS-sector by region
- ▶ Endogenous real emissions from ETS-sectors by linked region
- ▶ Endogenous number of transactions in the linked permit market (ideally)
- ▶ Endogenous number of market participants in linked permit market
- ▶ Endogenous volume of permit trade in linked permit market
- ▶ (Endogenous) volume of linked permit market

4.2 Summary of general model requirements

Table 4 summarises the general model requirements. It will be used for the general description of models in chapter 5.

Table 4: Summary of general model requirements for assessing economic effects of linking ETS

Model	Requirement
Type	Ideally CGE with bottom-up PE-elements in the energy sector + ideally in the industry sector; and ideally many econometrically estimated parameters
Time horizon of the agents	Ideally limited foresight optimisation
Time horizon of the model	Short- (less than 5 years) and long term (more than 10 years, ideally more than 35 years) (until 2020 annual steps, end date around 2050)
Economic fields	Domestic economy, international trade, linked permit market
Sectors	All ETS-sectors (energy, industry, domestic and partly international aviation for EU-ETS) + rest of the economy
Regions	EU-ETS31 + potential linking partners (e.g. China, South Korea, Mexico, Turkey) + Rest of the world (ROW)
Emissions	All ETS-gases from all ETS-sectors at disaggregated level (CO ₂ , N ₂ O, PFCs; from fossil fuel combustion and processes for a symmetric link of the EU-ETS)

Sectoral disaggregation	Disaggregation should be detailed enough to provide meaningful results, depending on the selected assessment criteria. When, for example, sectoral competitiveness-effects are to be assessed, a single-industry-sector model does not provide the information required (cf. Alexeeva-Talebi et al. 2012).
-------------------------	--

Wuppertal Institut, 2017, own compilation

4.3 Preliminary evaluation of economic models with regard to their suitability to assess economic effects of linking ETS

Models should be evaluated in a consecutive way: checking the regional coverage is followed by checking the coverage of sectors and emissions. Since a symmetric link between the EU-ETS and the potential linking partner is assumed, all models that have been analysed in this report cover the industry and the energy sector, as well as fossil fuel combustion and process emissions.

Requirements on the sectoral disaggregation may differ depending on the indicators to be analysed. The following preliminary evaluation will therefore first analyse to which extent the model outputs match to the economic assessment criteria and then, in a second step, if the sectoral disaggregation is sufficient for analysing the criterion. Eventually, the results of the evaluation provide, in combination, a first recommendation towards a preliminary shortlist of suitable models.

In order to reduce complexity, the impact of linking ETS on the non-ETS sectors is not covered in this analysis.

a) Coverage of relevant linking criteria and indicators

Within the framework of the research project that is the basis for this report eleven economic models that were principally deemed suitable for analysing the economic effects of linking have been assessed: The analysis comprised six CGE models (Aim-CGE, EPPA(-EU), GEM-E3, G-cubed, IMACLIM-R and PACE), one macro-econometric model (E3ME) and four PE models (POLES, PRIMES, REMIND-R, TIMES-M.). A special focus of the analysis was the question to which extent the models could be used to quantify the economic linking criteria and indicators (see table 1).

A summary of the results of the evaluation is given below. More detailed information can be found in the final report of the project (UBA forthcoming).

Linking objective: Reduce mitigation cost (static efficiency)

From the general equilibrium models, Aim-CGE, EPPA, GEM-E3, G-cubed and PACE can be used to compute both, the expected change of the permit price for sectoral mitigation costs and changes in economy-wide production for overall mitigation costs. The macro-econometric model E3ME can be used as well. From the partial equilibrium models, POLES, PRIMES, REMIND-R and TIMES are suitable to calculate changes in prices, but they do not report on endogenous changes in GDP.

Linking objective: Reduce competitiveness distortions – competitiveness and carbon leakage risk in relation to linking partner

The partial equilibrium models POLES, PRIMES, REMIND-R and TIMES could be used to quantify expected net capital flows. However, general equilibrium models cover as well net capital flows and are better suited to analyse the (sectoral) competitiveness effects in relation to the linking partner since they cover the entire economy. The macro-econometric E3ME model has the most detailed sectoral disaggregation, and provides hence the most useful information. PACE, Aim-CGE and GEM-E3 have as well a quite detailed sectoral disaggregation.

Linking objective: Reduce competitiveness distortions – competitiveness and carbon leakage risk in relation to linking partner

The partial equilibrium models POLES, PRIMES, REMIND-R and TIMES can be used to calculate the change in the permit price, and POLES might even quantify sectoral competitiveness effects. However, general equilibrium models are better suited to analyse (sectoral) competitiveness effects on the economy in relation to third countries, since they cover the whole economy. The E3ME model has the most detailed sectoral disaggregation, and provides hence the most useful information. Yet, PACE, Aim-CGE and GEM-E3 have as well a useful level of sectoral disaggregation. The partial equilibrium models only provide investments in the energy sector and are hence not useful for the assessment of this criterion. The hybrid model REMIND-R provides investments as an output, yet its single macro-economic sector is far too aggregated for any meaningful results.⁷

Linking objective: Increase market stability and liquidity

The indicator “number of market participants relative to the market size and the number of trades” consists de-facto of two indicators. Especially the first part of the indicator has some shortcomings. It stems from the assumption that more market participants means more *active* market participants, which is not necessarily true. Further, the size of firms in the market matters as well for market liquidity. It would be better to adjust the number of firms by their size, i.e. by calculating the Herfindahl-concentration-index⁸ if adequate data is available.

This very complex double-indicator is not covered explicitly in any of the considered models. When using an alternative criterion by comparing the trade volume relative to the market volume of the linked market with the not linked markets, the models GEM-E3, POLES, PRIMES and TIMES can be used.

b) Selection of most suitable models

Overall, the CGE models seem to be more suitable than the partial equilibrium models when all linking assessment criteria are to be covered, since they provide output for the whole economy and disaggregated for all ETS-sectors. Amongst the general equilibrium models, GEM-E3 has the best fit and covers all indicators almost completely. E3ME and PACE have as well a relatively very good coverage of the selected indicators relevant for the present analysis (see table 1). EPPA seems to be the least suitable in terms of indicator coverage among the CGE models.

For the PE models, REMIND-R covers the least criteria. Yet, all other PE models have major shortcomings, too. They suffer from the lack of detail and necessary output with regard to ETS-sectors other than the energy sector. Some PE models that cover the industry sector as well like POLES do not differentiate enough between different industry sectors. PRIMES, which has with 18 sectors the most detailed industry sector coverage amongst the PE models, does not cover non-CO₂-emissions. However, these models (POLES, PRIMES, TIMES) are still able to deliver quantitative results for at least one indicator for each assessment criterion.

Figure 3 provides an overview over how relevant assessment criteria and regions are covered in the eleven models covered by the overall analysis (see final report of the research project for more details).

⁷ Alternative indicators for this objective can be world export (import) prices relative to regions' export (import) prices (in Aim-CGE, IMACLIM-R, PACE), the regional carbon price relative to the third country's carbon price (in Aim-CGE), competitiveness-effects (in E3ME, IMACLIM-R, PACE), the carbon leakage rate (in PACE) and changes in relative production costs (in TIMES).

⁸ The Herfindahl concentration index (or Herfindahl-Hirschman Index HHI) measures the size of firms in relation to the industry, which indicates the amount of competition among firms. It is defined as the sum of squares of the market shares (as fractions of the total market) of the firms within the industry. The index ranges from 0 (huge number of very small firms) to 1.0 (single monopolistic producer).

Figure 3: Overview on how assessment criteria for linking ETS and regions are covered in existing models

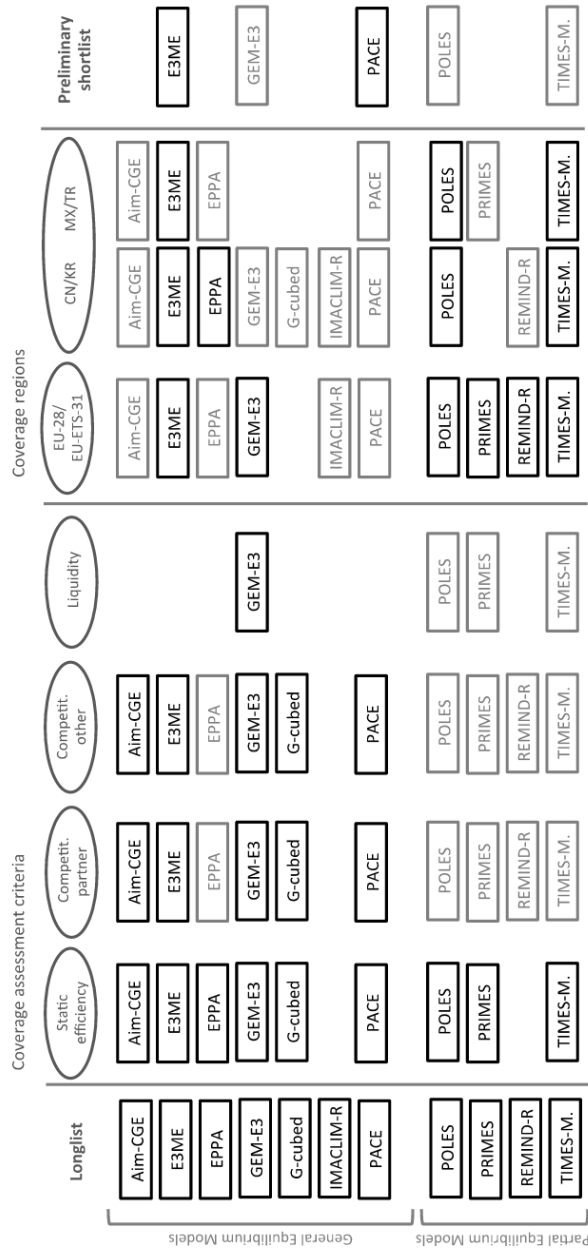

Light grey means that the model covers parts of the requirements, but not entirely or with some shortcomings (see descriptions for more details).

5 Model description

The previous sections have focused on how and to which extent the requirements for assessing the economic effects of linking ETS are fulfilled by the models (“models by requirements”). The following model descriptions analyse the same topic from the opposite viewpoint: they describe the models in light of the requirements (“requirements by model”). The previous analysis has shown that none of the models perfectly fulfils the requirements. Some models perform better in terms of regional coverage, some perform better in terms of criteria coverage (usually the CGE models), some provide a compromise with good but not optimal regional and criteria coverage at the same time.

Based on these observations and a more extensive analysis of all eleven models considered in the research project, five models have been identified as most suitable⁹ for the present analysis, which will be described in more detail in this section¹⁰:

- ▶ E3ME (Macro-econometric model)
- ▶ GEM-E3 (general equilibrium model)
- ▶ PACE (general equilibrium model)
- ▶ POLES (partial equilibrium model)
- ▶ TIMES-MARKAL (partial equilibrium model)

Only two models are useful as stand-alone models for analysing linking effects: **E3ME** with the most useful combined regional and criteria coverage and high sectoral disaggregation and **PACE** with generally good criteria coverage and flexible regional coverage, however, depending on available data. The three remaining models **POLES** (good regional coverage, detailed permit market module), **TIMES-MARKAL** (very flexible) and **GEM-E3** (most useful criteria coverage, limited regional coverage) have some limitations. Nevertheless, they seem to be very useful to complement the stand-alone models in the analysis, since they fulfil some requirements that E3ME or PACE do not fulfil at all or not as detailed as required. In order to complement the descriptions with more detail, some interviews with the modellers have been conducted.

Each description starts with an overview table on the fulfilment of the model requirements (compare Table 4). The colour-code in these tables reads as follows:

Green = Model sufficiently fulfils the respective model requirement

Grey = Model partly fulfils the respective model requirement

Red = Model does not fulfil the respective model requirement

The paper concludes with an overview table (Table 10) on the fulfilment of criteria by model.

⁹ The suitability of the model for the present analysis does not hinge on a simple adding up the “green” (i.e. fulfilled) requirements. The colours only provide a first hint on how well the respective model requirement is covered. Models may more or less easily be adapted to fulfil requirements or public information may be insufficient to assess the fulfilment level appropriately. The fulfilled requirements may also differ in terms of quality and not all requirements are equally important. Therefore, simply selecting the model with the largest amount of “green” requirements does not necessarily lead to the most useful model for analysis.

¹⁰ Information on all models can be found in the final report of the research project (UBA forthcoming).

5.1 E3ME

Table 5: Summary E3ME

Model	Energy-Environment-Economy Macro Econometric Model (E3ME)
Author	Cambridge Econometrics
Type	Macro-econometric, Demand-driven flows in input-output tables, non-equilibrium model (markets do not necessarily clear)
Time horizon of the agents	myopic agents
Time horizon of the model	Short- and long run 1995-2050 (latest calibration period: 1970-2014), annual time steps
Economic fields	Domestic economy, bilateral international trade, linked permit market
Sectors	EU: 69 product/industries; defined in terms of NACE Rev.2 (with separate aviation) Other countries: 43 product/industry classifications, defined in terms of the NACE Rev1.1 (with separate aviation)
Regions	Global: 53 countries (incl. 28 EU-member states + Norway, Iceland (not Liechtenstein), 11 other major economies in countries (incl. China, South Korea, Mexico, Turkey), rest of the world in aggregated regions)
Emissions	CO ₂ , SO ₂ , NO _x , CO, CH ₄ , PM ₁₀ , VOC, CFCs, N ₂ O, HFCs, PFCs, SF ₆ ; from fossil fuel combustion and processes; reported only CO ₂ per sector, others reported by region
Main databases	<ul style="list-style-type: none"> - Accounting balances for commodities from input-output tables and for institutional incomes and expenditures from the national accounts: Eurostat, AMECO, Asian Development Bank, OECD's STAN database, UN, OECD, World Bank, IMF, ILO and national statistics - Bilateral trade: Comtrade (for manufacturing), OECD (services), national statistics - Energy fuel use and energy efficiency technology development: IEA energy balances and IEA Energy Technology Perspectives for FTT:Power - Energy price data: IEA Energy statistics by country and fuel - CO₂ emissions by fuel and user: EDGAR, Eurostat

Wuppertal Institut, 2017, own compilation

The E3ME (Energy-Environment-Economy Macro Econometric Model) is not a CGE model but an economy-wide macroeconometric model that can be used to answer similar questions like CGE models with econometrically estimated, rather than calibrated parameters. The energy modelling in E3ME is top-down, but with bottom-up elements in the electricity supply sector (Cambridge Econometrics 2014, p.17 + 120). Its econometric parameter estimation provides a strong empirical basis for analysis and avoids making strong assumptions about agents' behaviour.

Since it is an econometric model, no production functions are defined. The model is rather based on national accounts for incomes and expenditures, input-output tables for commodities and energy balances for energy carriers. It has two-way linkages between each of the energy-environment-economy

component and solves 33 sets of time-series econometrically estimated equations, including all GDP components, prices, energy- and materials demand; all by country and by sector (Cambridge Econometrics 2014). By providing results by yearly time steps until 2050, the model captures short- and long-run impacts of linking.

The driving principles are demand-driven flows in input-output tables. The econometric model is a non-equilibrium model, which means that markets do not necessarily clear. It is hence not an optimisation model. However, it assumes myopic agents. Since myopic agents discriminate against potentially fundamental (i.e. very low-carbon) investments in technologies that pay off only in the mid- or long-run, the analysis of dynamic efficiency effects provides limited results in this model setting. However, for analysing the effects of linking on the selected criteria in the short-run, the model can be used. By its econometric specification it provides results that build on observed values.

The domestic economy, bilateral international trade and the linked permit market are all covered. The endogenous GHG emissions are reported by sector and fuel (Cambridge Econometrics 2014, p. 14).

Permit market

The model simulates the permit market by taking either the annual emission caps or emission prices as exogenous input. The cap can be set for any choice of the 22 energy users in the model via a switch. This allows for a differentiated treatment between ETS-sectors and non-ETS-sectors. The default-version of the model covers the EU-ETS sectors, including aviation (Cambridge Econometrics 2014, p.39 + 106). The main constraint highlighted by the modellers is that the IEA energy users do not match up 100% with the ETS coverage. For example, no allowance is made for small installations and the 'other industry' category that includes multiple use plants.

The estimated annual permit price corresponds to the shadow-value of carbon for those sectors covered by the ETS. It is hence not possible to account for permit market distortions and price volatility in the model (Cambridge Econometrics 2014, p.106f.). Plotting different levels of endogenously estimated annual permit prices to the corresponding pre-defined emission caps gives the MACC.

Two different allocation methods, auction or free allocation (setting the auction price at zero), can be chosen. It is assumed that the allocation method does not have an impact on the firms' product pricing decision (marginal pricing); yet this assumption can be altered by changing the model code (Cambridge Econometrics 2014, p.106f.). E3ME assumes that the price signal resulting from permit trade corresponds to the signal of a carbon tax, i.e. that there is no uncertainty and volatility with regard to future permit prices (Cambridge Econometrics 2014, p.107). This limits the usefulness of the model to analyse dynamic efficiency, since investment decisions are strongly influenced (get more expensive) with increasing uncertainty and volatility.

Unfortunately the model only reports CO₂ by sector, the other ETS-gases are reported by region. Therefore, separating between ETS- and non-ETS sectors is only possible for carbon trading (Cambridge Econometrics 2014, p.20).

Modelling an ETS that covers GHG other than CO₂ is in principle possible, according to the modellers. However, the coverage of non-CO₂ emissions would be much more limited, i.e. the model cannot provide details on the agricultural sector since this sector is out of scope of the model.

According to the modellers, the model can be used for modelling a basic linking scheme with free trading between regions. Further, E3ME can be adapted to model a linked permit market with constraints on the number of allowances traded between the regions or, as Australia was suggesting, only a one-way trade.

By default, the model is solved on an annual basis, hence annual caps / permit prices are required as an input. According to the model manual, prices are set in two ways: When the allowance price is exog-

enous, it is entered by the model user. For an endogenous allowance price, the user must set the emission cap. The model will then estimate the price required to meet the cap through an iterative process. Banking and borrowing might be an option when being imposed by the assumption of perfect foresight (Cambridge Econometrics 2014, p.106 and 108).

Albeit the model provides a wide range of permit market features and specifications like offset quota or banking and borrowing, it is not suited for analysing market liquidity, since it does not include transaction costs and does not model the amount of firms in the market (Cambridge Econometrics 2014, p.107). A model that solves on a monthly basis would be more appropriate for estimating the effects of linking ETS on permit market liquidity. Further, the number and size of market participants cannot be reflected in E3ME. The model defines the permit market by sectors and all the participants in each sector are assumed included. Therefore, more sectors implies more participants. Market power and market concentration in the permit market is neither modelled. There is only some of this implicitly in the pricing equations: More powerful market operators have more freedom to set the industry price and the econometric equations should reflect this. The number of trades in the permit market is only modelled in net terms, i.e. if allowances are allocated to one sector and used by another. Secondary trading is not covered by E3ME.

International trade

In combination with the detailed sectoral and regional coverage (see below), especially the endogenous bilateral trade flows enable a sound analysis of the effects of linking on competitiveness and carbon leakage. E3ME models bilateral trade flows by region and sector and distinguishes between imports and exports intra-EU and to third countries (Cambridge Econometrics 2014, p.55f). It takes into account the effect of innovation on the long-run trade performance, which is an important component in the area of dynamic efficiency to analyse carbon leakage and competitiveness effects. Further, the model assumes oligopolistic pricing in international markets, which further has an effect on carbon leakage and competitiveness (Cambridge Econometrics 2014, p.65).

The model explicitly reports competitiveness effects through several equations. In E3ME, competitiveness is defined as production levels of a two-digit sector due to changes in its cost base. The two-digit base¹¹ is a shortcoming (common to most macroeconomic models) as competitiveness effects are felt at a much more detailed level (e.g. aluminium rather than non-ferrous metals, cement rather than non-metallic mineral products). When estimating the effects of linking ETS on competitiveness, the assumed underlying reaction chain is higher (lower) carbon prices – higher (lower) production costs – higher (lower) product prices (depending on how much the cost change is passed through to the consumer) with separate price variables for domestic production, imports and exports – loss (gain) of output. A loss of output occurs through substitution of domestic products with imports and/or reduced exports. Gains are realized through increased consumption of domestic products and/or increased exports. The loss (gain) of output due to the increase (decrease) of production costs is then the competitiveness-effect. Overall, modelling the competitiveness-effects of domestic ETS-sectors in relation to the ETS-sectors of the linking partner and in relation to similar sectors in the rest of the world is possible with E3ME.

¹¹ In these models, industrial details are often very aggregated. Usually aggregation is done at the one-digit Standard Industrial Classification (SIC) level or, at most, the two-digit SIC level. SIC codes have a hierarchical, top-down structure that begins with general characteristics and narrows down to the specifics. The first two digits of the code represent the major industry sector to which a business belongs. The third and fourth digits describe the sub-classification of the business group and specialization, respectively.

Domestic economy

Sectoral output (Gross Value Added, GVA) at market prices and factor costs and investments are endogenous in E3ME (Cambridge Econometrics 2014, p.14), which is useful to analyse static and dynamic efficiency effects for the domestic economy.

As mentioned above, production functions are implicit through input-output tables, with the input-output coefficients related to energy changing in response to the energy equations. So if e.g. a higher carbon price reduces coal consumption by the steel sector, the economic part of the model will show both reduced demand for coal and also (assuming the elasticity <1 and costs are passed on) a higher price for steel.

The model has a very detailed sectoral coverage of all EU-ETS sectors and sectors in the rest of the economy. For the EU, it disaggregates 69 industries, which are defined in terms of NACE Rev.2, including aviation. For the other countries, 43 industries are covered, defined in terms of the NACE Rev.1.1, including aviation. In combination with the detailed regional coverage, and the simulation of bilateral trade flows, the model is very well suited to analyse effects of linking on carbon leakage and competitiveness, regarding the linking partner and third countries. The model even explicitly reports competitiveness effects.

Regional coverage

E3ME provides output at a very detailed regional disaggregation, which perfectly fits the requirements for the present project. It explicitly reports results for 53 countries, including the 28 EU member states plus Norway and Iceland. An aggregation of the 28 EU member states plus Norway and Iceland comes close to the EU-ETS-31 group (only Liechtenstein lacks in the country coverage which is unlikely to have a significant impact on results). The model covers further 11 other major economies as countries.

This level of disaggregation further provides a solid basis for a meaningful analysis of carbon leakage and competitiveness effects for linked ETS sectors with regard to third countries or the linking partner.

Dynamic efficiency and technological progress

The model's approach to energy technology usage and (energy efficiency) technological development differs between the power sector and the industry. In the power sector, a model of technology diffusion, called FTT:Power, is employed. The model is based on evolutionary economics and predicts the uptake of new and existing technologies based on a range of different policy factors, including carbon prices. There are 24 power-technologies available, each with data on capital, fuel, operation and maintenance costs and other costs from which a levelised cost is calculated and fed into the diffusion dynamics. Nuclear and CCS are included in this list. Yet, according to the modellers, nuclear is often modelled by assumption as its application is mostly a political decision.

For the other industries, the modellers are recently working on a similar technology diffusion model like for power, FTT:Industry. The current treatment is however still top-down econometric equation. Price elasticities are either estimated from time series data or, cross-sectional econometric estimates from the available literature or by the modellers are used. The exact econometric equation specification is: Energy consumption = F(economic activity, price, investment, R&D) - with the last two terms accounting for efficiency in the capital stock. The model accounts further for fuel switching. Like when estimating total energy consumption equation, there are similarly estimated equations for coal, oil, gas and electricity, with the totals scaled to be consistent with total energy consumption.

Data sources for technology expansion rates and associated costs (learning curves) for renewable energy and energy efficiency are mainly IEA Energy Technology Perspectives for FTT:Power (updated recently) and for the other industry IEA Energy Balances balances linked to Eurostat or equivalent data, updated roughly once per year.

In general, the model does not deal explicitly with dynamic efficiency. Any hint on dynamic efficiency would need to be extracted from the empirical data. For example in the power sector, if there is a shift to capital-intensive renewables or nuclear then there will be a short-term boost to economic activity that is funded by higher debt levels. Over time, however, this debt must be paid off through higher electricity prices, so there is a dampening effect. Nevertheless, dynamics such as learning effects and path dependency are taken into account, which mean that the net impact will not necessarily be zero over time.

Investments in E3ME are reported as Gross Fixed Capital Formation, which is determined through econometric equations estimated on time-series data. Key determinants of investments in E3ME are expectations of future output, relative prices and interest rates (Cambridge Econometrics 2014, p.13).

The model estimates innovation and technological progress with a quality-adjusted measure of cumulative gross-investment, altered by using data on R&D expenditure. Technological change occurs in the form of product and process innovation (efficiency improvements of existing technologies and replacement of technologies by more efficient technologies) (Cambridge Econometrics 2014, p. 24ff + p.46.).

Latest update

The latest model version 6.0 is from 2014, which replaced the 2012 version. However, the manual for version 6.0 lists some further improvements planned like the incorporation of measures of consumption-based emissions, revisions to the energy equations and price elasticities, revision to the system used to estimate model parameters, a more disaggregated treatment of taxes within the model and the investigation of coupling further bottom-up submodels (e.g. transport) (Cambridge Econometrics 2014, p.8). A data update will be carried out before the end of 2016, when Eurostat published data for 2015.

Figure 4: E3ME model structure as an E3 model without additional modules

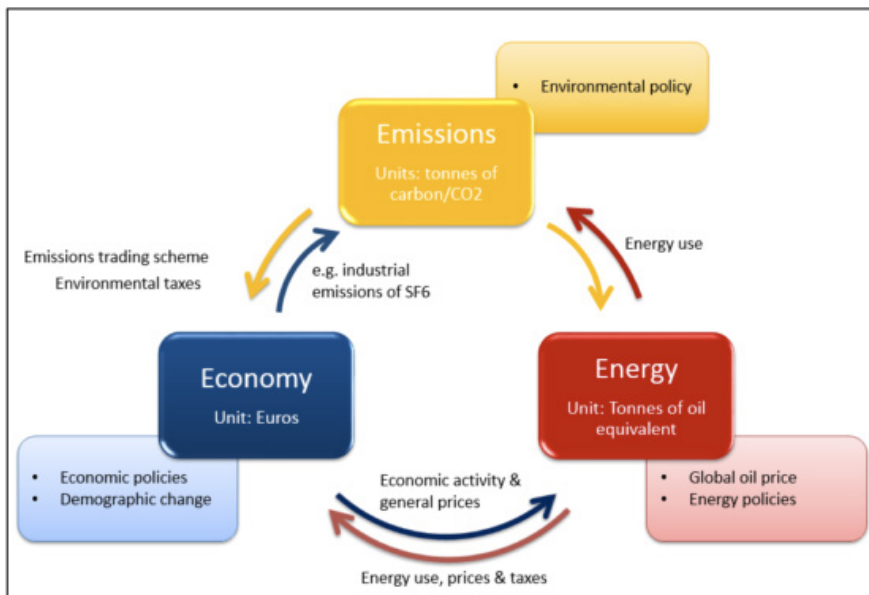

Source: Cambridge Econometrics 2014, p.11

Figure 5: E3ME model structure as an E3 model with additional modules

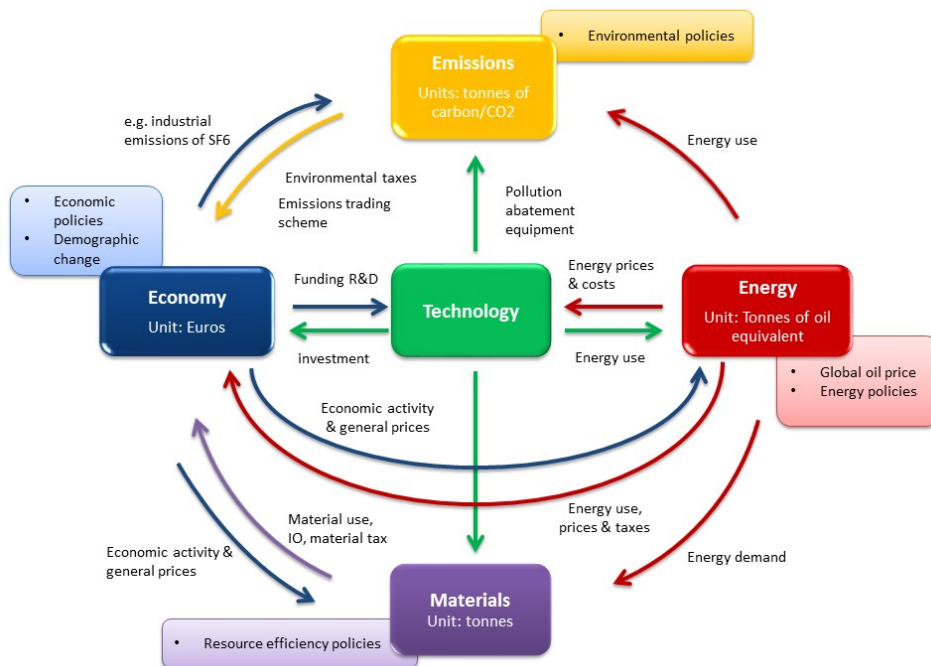

Source: http://www.camecon.com/EnergyEnvironment/EnergyEnvironmentEurope/ModellingCapability/E3ME/purpose_and_design.aspx

5.2 GEM-E3

Table 6: Summary GEM-E3

Model	General Equilibrium Model for Economy - Energy – Environment (GEM-E3)
Author	National Technical University of Athens/ E3M Lab/ European Commission (JRC Sevilla) / (formerly) KU Leuven
Type	General equilibrium with bottom-up technology representation in the energy sector
Time horizon of agents	Myopic optimisation, recursive dynamic
Time horizon of model	2004-2050, 5-year time steps
Economic Fields	Domestic economy, international trade, linked permit market
Sectors	Up to 56 sectors (GTAP database aggregation), default: 31 production sectors (of which 5 energy sectors and 10 power production technologies; 9 industry sectors, 1 agriculture, aviation, no forestry)
Regions	Global : Aggregation flexible, up to 140 regions (GTAP database) Default: 38 regions <ul style="list-style-type: none"> - 28 EU member states (Austria, Belgium, Bulgaria, Croatia, Cyprus, Czech Republic, Germany, Denmark, Spain, Estonia, Finland, France, United Kingdom, Greece, Hungary, Ireland, Italy, Lithuania, Luxembourg, Latvia, Malta, Netherlands, Poland, Portugal, Slovakia, Slovenia, Sweden, Romania) - USA - Japan - Canada - Brazil - China - India - Oceania - Russian federation - Rest of Annex I (incl. Turkey) - Rest of the World (incl. South Korea, Mexico)
Emissions	CO ₂ , CH ₄ , N ₂ O, HFCs, PFCs, SF ₆ ; from fossil fuel combustion and processes; by sector
Main databases	<ul style="list-style-type: none"> - Social accounting matrix: world version uses GTAP (European version ceased to exist as an independent version and has been integrated in the world version) . JRC Sevilla (European Commission) collaborates with GTAP in order to guarantee the consistency between the GTAP dataset and EUROSTAT) - Bilateral trade matrices incl. duties and transportation costs: GTAP, UN Comtrade, COMTEXT - Capital stock data by production sector: own calibration - Population and population growth, labour force, involuntary unemployment: EUROSTAT, ILO and World Bank, CESifoDICE

Model	General Equilibrium Model for Economy - Energy – Environment (GEM-E3)
	Standard assumptions are (but can be adapted according the context): <ul style="list-style-type: none"> - Economic growth projections: European Commission growth projections for EU countries; IMF and World Bank growth projections for rest - GHG emissions: UNFCCC database - Process-related GHG MACC: Global mitigation of non-CO2 GHG, EPA report (2006), and IIASA GAINS database

Wuppertal Institut, 2017, own compilation

GEM-E3 (General Equilibrium Model for Economy – Energy – Environment) is a recursive dynamic multi-regional computable general equilibrium model with bottom-up technology representation in the energy sector (Capros et al. 2013, p.123f.). The large-scale model provides information about the macro-economy and its interaction with the energy system and the environment. It is based on social accounting matrices (SAM). Amongst others, the model input and output consists of national accounts, full input-output tables, household consumption, energy use and supply and GHG emissions (Capros et al. 2013, p.13). The parameters are mostly calibrated by a calibration module, which is written as a separate model with recursive structure (Capros et al. 2013, p.81, cf. the extensive treatment of calibration and estimation in general with a variety of references to the literature in the same document, p.80ff.).

The model provides results in 5-year time steps until the year 2050 and is hence especially useful for the analysis of structural change in the medium run (Hedenus et al. 2012, p.19). One cannot use the CGE methodology to analyse short-run fluctuations, which might be important for analysing the development of the emission permit price shortly after having linked two ETS. The driving principle is myopic optimisation.

GEM-E3 provides a useful treatment of the areas required for the criteria analysis like the domestic economy, bilateral trade and the linked permit market. It endogenously calculates GHG emissions by region and sector (Capros et al. 2013, p.13, 16). In terms of permit market coverage, it is the most suited model compared to the other models considered in this annex for the present purpose.

Permit market

GEM-E3 features a detailed environment and emissions module that allows for a variety of ETS design options like different allocation schemes, various systems of exemptions like a carbon leakage list and revenue-recycling, etc., for sectoral, national and worldwide policy evaluation (Capros et al. 2013, p.19 + p.115ff.). Modelling the permit price of linked ETS is possible with GEM-E3.

GEM-E3 is very flexibly adaptable for analysing the effects of linking ETS on economic indicators. Differentiation between caps for the ETS-sector and the non-ETS-sector is possible, since the switch parameter for the scenario definition can be adapted with respect to the target level (branch level, regional level or club level, all relative to 2005 emissions), pollutants (hence all EU-ETS pollutants can be considered), activities, countries and time (Capros et al. 2013, p.126). The module allows for user-defined regional trade and trading-bubbles (Capros et al. 2013, p.14, p.114-127).

The permit price is the market clearing price from the permit market supply- and demand equilibrium. Therefore, it might differ from the emission shadow price (Capros et al. 2013, p.123f.).

There is no explicit abatement cost function applied to determine the permit price. Emissions can be reduced either by end-of-the-pipe solutions (not for CO₂), output reductions, substitution towards low-carbon inputs, low-carbon production or buying emission permits.

As mentioned above, in order to reduce CO₂ emissions, firms have to substitute fuel input or reduce overall production or make it more carbon-efficient. For non-CO₂ emissions, end-of-the-pipe abatement is an option. For the firm to decide between purchasing emission permits and the optimal level of end-of-the-pipe abatement, the emission price is taken into consideration. Emissions will be abated until the cost to abate an additional ton of emissions equals the permit price per ton (Capros et al. 2013, p.118f.).

In line with these emission abatement options, the model provides information on the links between emission constraint and pollution abatement investments (Capros et al. 2013, p.15f.), as well as on permit purchases with the corresponding expenditures and on sales with the respective monetary receipts, by branch (Capros et al. 2013, p.123f.). This enables an analysis of the trade volume in the permit market, which could serve as a proxy for market liquidity. Assuming perfect market clearance, GEM-E3 is not able to explicitly model market liquidity constraints.

GEM-E3 is, according to the modellers, not useful to model market power and market concentration, unless major model changes are undertaken.

GEM-E3 provides as well estimates of total abatement costs. Production prices reflect the costs of technologies for process-related emission reductions and expenditures for permit purchases. When using grandfathering as the allocation method, the unit costs of production might optionally be reduced by the amount of free permit endowments, depending on how opportunity costs are to be treated in the model.

International trade

Full endogenous input-output-tables with bilateral trade flows and capital mobility by sector allow for a detailed analysis of carbon leakage and competitiveness effects with regard to the linking partner and third countries (Capros et al. 2013, p.58, 62). This analysis might be more realistic than in other models regarding trade elasticities: GEM-E3 not only differentiates goods between domestic and foreign for the Armington assumption, but between domestic, EU and the other countries (Capros et al. 2013, p.16, 58).

In addition, GEM-E3 allows for alternative competition regimes in addition to perfect competition and for different market clearing mechanisms, which might give even more realistic results regarding the analysis of competitiveness-effects and carbon leakage (Capros et al. 2013, p.14).

Domestic economy

GEM-E3 models sectoral output, capital stock, exports and imports by sector and region in terms of GVA (Capros et al. 2013, p.29, 53). Cross-border investments are as well covered, which is important for the analysis of competitiveness-effects of linking (Capros et al. 2013, p.17). Production is modelled through capital, labour, energy and materials (KLEM) production functions, which involve many intermediate goods and three primary factors (capital, natural resources, labour). The model captures complexities in behaviour via micro-economic mechanisms and institutional features within the macro-economic framework to avoid making simplistic behavioural assumptions.

Three ways of emission abatement are specified: Input substitution (between intermediate goods input, fuels and between energetic and non-energetic inputs), reduction in production and consumption, investment in emission abatement technologies.

Costs for complying with the policy instruments, i.e. the permit market, are added to the input price. Thereby, they enter the final consumption prices (Capros et al. 2013, p.115). Increasing (decreasing) prices lead to reduced (increased) final demand, which can serve as another proxy to overall economic effects of linking and the effects of linking ETS on sectoral production.

The model disaggregates 31 production sectors, including 9 industry sectors, 5 energy sectors with 10 power production technologies and aviation. Hence, all EU-ETS sectors are covered. Possible model

extensions to provide more technological detail in the energy sector can be done by using the TECHPOL, Enerdata, POLES or PRIMES model databases (Hedenus et al. 2012, p.31).

Regional coverage

GEM-E3 is a global model with 38 regions, which enables in principle a meaningful analysis of carbon leakage and competitiveness-effects for linked ETS-sectors with regard to third countries and the linking partner. Regional coverage of the EU-ETS-31 countries is relatively good in GEM-E3: The individual 28 EU member states can be aggregated to the EU-28 region, which comes close to the EU-ETS-31 region (only Liechtenstein, Iceland and Norway are missing, yet since these are relatively small countries, this should be acceptable). However, China is the only potential linking partner in the focus of this analysis for which the model provides country-level results. South Korea and Mexico are both included in the “Rest of the World” region, and Turkey enters the “Annex 1”-group, where the non-EU-ETS-countries are included as well.

Dynamic efficiency and technological progress

According to the modellers, assumptions on technological deployment, technological usage and technology costs are introduced in GEM-E3 through the linkage with identical scenarios modelled by partial equilibrium energy models like POLES and PRIMES (or other). For the macroeconomic figures, there are assumptions on the factor-specific technical progress factors (i.e. capital, labour, energy).

Technological change is, amongst others, mainly reflected by price-changes of end-of-the-pipe abatement and by changes in the relative productivity of different production factors.

Data and assumptions for reflecting technological progress are constantly updated.

Since GEM-E3 is not a forward-looking model (i.e. firms’ decisions are not based on expectations but on profit maximization for the current period), and innovation is exogenous to the model, GEM-E3 is not well-suited to analyse dynamic efficiency. Any dynamic behaviour in the energy system is, according to the modellers, implicitly introduced through the linkage with POLES, PRIMES or other suitable partial equilibrium models.

Latest update

Since the model uses the GTAP database for the world version, GEM-E3 could be re-calibrated with each update of the GTAP database. According to the modellers, the model is continuously being updated and improved.

5.3 PACE

Table 7: Summary PACE

Model	Policy Analysis based on Computable Equilibrium model (PACE)
Author	ZEW Mannheim
Type	General equilibrium with technology-discrete bottom-up electricity sector representation
Time horizon of the agent	Forward-looking rational expectations or myopic, maximisation of life-time-utility, 3 different time treatments: comparative-static, dynamic-recursive, inter-temporal
Time horizon of the model	target year 2050 in 5-year time-steps,
Economic Fields	Domestic economy, international trade, linked permit market
Sectors	36 production sectors incl. 9 disaggregated energy intensive sectors
Regions	<p>Global: 23 world regions, flexible with available data</p> <p>EU-27 regions:</p> <ul style="list-style-type: none"> - Germany - France - UK - Italy - Spain - Poland - XEO: Rest of old EU Member States plus Cyprus and Malta (Denmark, Sweden, Finland, Austria, Belgium, Netherlands, Luxembourg, Ireland, Portugal, Greece, Malta, Cyprus) - XMT: Rest of new EU Member States (Czech Republic, Slovakia, Hungary, Slovenia, Bulgaria, Romania, Estonia, Latvia, Lithuania) <p>Other Annex I regions:</p> <ul style="list-style-type: none"> - USA - Canada - Japan - Russia - Australia - Turkey - RAX: Rest of Annex I (Switzerland, Norway, Iceland, Liechtenstein, Ukraine, Belarus, New Zealand) <p>Non-Annex I regions:</p> <ul style="list-style-type: none"> - China (incl. Hong Kong, excl. Taiwan) - India - Brazil - South Korea - Indonesia - Mexico - South Africa - Rest of the World

Model	Policy Analysis based on Computable Equilibrium model (PACE)
Emissions	CO2 (process emissions and emissions from burning fossil fuels reported by sector), no other emissions
Main databases	<ul style="list-style-type: none"> - Production, Consumption, bilateral trade flows: GTAP 9 (140 regions, 57 sectors) - alternative databases for production, imports, exports, intermediate and final consumption e.g. EXIOPOL 2011 (http://www.exiobase.eu/, for free, very detailed sectoral classification with 129 sectors and 43 countries) - Further more disaggregated Input-Output data: Eurostat 2011 Structural Business Statistics; UN Industrial Commodities Statistics, WIOD (World Input-Output database) - Import and Export shares: Eurostat External Trade Data; UN Comtrade data - Energy and emission data: IEA - Exogenous technological progress (AEEI): derived from GTAP data - BAU projections non-EU regions: most recent projections from the International Energy Outlook US Department of Energy 2013 for GDP growth, fossil fuel production and prices, carbon emissions, future energy prices - BAU projections EU regions: project specific baseline based on projections by PRIMES used for calibration

Wuppertal Institut, 2017, own compilation

The PACE model is a flexible global general equilibrium model system with bottom-up discrete energy technology modelling (formerly PACE-BU module, now part of in the standard model). It provides a framework for the analysis of global trade and energy use (Alexeeva-Talebi et al. 2012, p.4f.).

The model is based on a set of equations like zero profit, market clearing and income balance that reflect a set of assumptions like profit-maximizing behaviour, constant returns to scale in production and perfect competition. It is therefore a classical optimisation model where a solution algorithm finds the set of endogenous quantities and prices that solve the equations simultaneously.

The user can choose between static, dynamic-recursive and inter-temporal time treatments. The driving principle is either forward-looking with rational expectations or myopic, it unfortunately lacks the limited foresight option. Parameters are calibrated with benchmark data from the base year (regularly updated with every new GTAP version; recently it is the year 2011, using extrapolated data from the GTAP 9 database (Source: modeller in interview). The model proceeds in 5-year time steps until the target year 2050.

The model covers CO2 emissions from burning fossil fuels and process based CO2 emissions. Other GHG are not included. According to the modellers, including them is in principle possible, but not planned at the moment.

PACE covers the areas, which are relevant for the present analysis: The domestic economy, international trade, and the linked permit market.

Permit market

When simulating emission trade, one can run the model with a cap on ETS-sectors, and a carbon tax for non-ETS sectors (at least in the EU) to meet the national overall emission cap. Therefore, the model is well suited to analyse not only the effects of linking ETS on ETS-sectors, but as well on the abatement burden of further non-ETS sectors, assuming that the overall national emission caps are binding. Allocation is centralised and mostly done via auctioning; however there are several allocation rules

available, that distinguish as well between sectors. For example, the recent EU-ETS allocation scheme can be replicated in the model, which is very useful for the present analysis. Revenues from allocation other than free allocation are redistributed in a lump-sum way to the agents.

Permits are connected directly to the fossil fuel inputs with zero elasticity of substitution (Leontief). Hence, the permit price is computed directly as a consequence of increased/decreased demand for fossil fuel inputs. It therefore equals the shadow value of carbon, resulting from the implementation of the carbon constraint (Böhringer & Lössel 2004, p.4). With different levels of stringency of the carbon constraint, the MACC can be derived for each region or each ETS. By this, the relative permit prices in each region and the expected changes through linking can be calculated¹². It is important to note that the resulting permit price relies on perfectly competitive markets without information asymmetries and other market failures; otherwise, the shadow value of carbon is not necessarily equal to the permit price.

With respect to permit allocation, the zero profit condition plays an important role: With zero profits, firms cannot pass on any permit costs to the consumer under a free allocation scheme.

The model allows for free trading of allowances. Therefore, the EU ETS can be modelled. Yet, market regimes other than perfect competition are not an option.

Further, linked permit markets can be explicitly analysed with PACE. The previous PACE-FlexMecs module, which simulates emission trading between countries, is now part of the standard PACE model. Again, only markets with perfect competition can be modelled.

Since financial markets are not included in the current model version (and are not planned to be included in the future according to the modellers), permit market liquidity cannot be modelled. Neither is PACE suited to model the number of market participants in the permit market, nor market power and market concentration (only perfect competition), or the number of trades in the permit market. Yet, the size of market participants can be modelled.

The model distinguishes explicitly between ETS and non-ETS sectors. In order to guarantee that the total national emissions target is met, the model estimates country-specific carbon taxes such that the national specific emission reduction targets are met.

International trade

Trade in goods occurs under the Armington-specification, and trade elasticities are, like the other parameters, estimated with the base year data (Alexeeva-Talebi et al. 2012, p.4f). PACE endogenously provides estimates for sectoral production per region and trade exposure, i.e. the share of exports for a specific sector in a certain region and aggregate exports and imports per sector and region (Alexeeva-Talebi et al. 2012, p.8).

PACE further provides the effect of a policy on competitiveness (Alexeeva-Talebi 2009, p.13) and the carbon leakage rate as part of the model output. Yet the model's definition of carbon leakage ("Change in foreign emissions relative to share of domestic emission reductions", see (Böhringer et al. 2009, p.7) is not entirely correct (it would be "Change in foreign emissions due to (policy-induced) domestic emission reduction"). The competitiveness-effects are reported by policy-induced sectoral output changes, sectoral value added changes, sectoral employment effects and sectoral market shares. It is possible to model the competitiveness-effects of domestic ETS-sectors in relation to the ETS-sectors of the linking partner and in relation to similar sectors in the rest of the world.

Since the latest PACE version, capital is mobile between regions. Hence, net capital flows can be calculated.

¹² Permits are connected directly to the fossil fuel inputs with zero elasticity of substitution (Leontief). Hence, the permit price is computed directly as a consequence of increased/decreased demand for fossil fuel inputs.

Domestic economy

GDP and production per sector and region are endogenous in PACE (Alexeeva-Talebi et al. 2012, p.8). Investments per region are endogenous, too; yet they are not disaggregated by sector (Böhringer et al. 2009, p.21). Production in the domestic economy is calculated with aggregate production functions, where technology is characterised through different substitution possibilities between the inputs (Böhringer & Lösschel 2004). The substitution possibilities between capital, labour, intermediate inputs, energy and non-energy are specified by nested CES (constant elasticity of substitution) cost functions at three levels. CES functions are a particular type of aggregator function, which combines two or more types of inputs into an aggregate quantity. In presence of a carbon pricing scheme, fossil fuels as production input (i.e. oil, natural gas, coal) are tied to a fixed proportion of emission permits. Hence, the CES function allows for substituting the fossil fuel input by other inputs as reaction to an increasing carbon price.

The endogenous price of each output is given by the unit costs to produce this good, which corresponds to the marginal and – due to constant returns to scale – the average costs of production.

The sectoral coverage in PACE is very detailed, and distinguishes between ETS and non-ETS sectors. This is very useful for a meaningful analysis of the economic effects of linking on individual ETS and non-ETS sectors. The most recent model version distinguishes 36 sectors in total, of which 26 industrial sectors that include nine disaggregated energy intensive sectors (Fertilizers and other nitrogen compounds; Organic chemicals; Inorganic chemicals; Cement; Bricks, tiles and construction products; Glass; Ceramics; Manufacturing of iron and steel; and Aluminium) beyond the sectors in the GTAP 9 data base as an extended feature. In addition to the industrial sectors, five extractive activities (from agriculture to mining) and five services (including transport) are covered.

The electricity sector is modelled in a bottom-up module, which entails different power producing technologies (coal, refined oil, gas, nuclear, renewable energy carriers) (formerly PACE-BU model, now part of the standard version). Like for the other sectors, the electricity sector can substitute between different inputs. The bottom-up technological choices in the electricity sector influence permit prices, capital flows etc. in the entire economy (i.e. in non-electricity sectors as well).

Regional coverage

The default model specification covers 23 world regions, of which the EU-ETS-31 is not explicitly reported. However, the EU-27 member states are reported at a relatively high level of detail. The six largest economies of the old EU member states as well as Poland as the largest economy of the new member states are included as separate regions. The remaining EU-27 countries are gathered in two groups. Croatia is not covered, yet. Further, Iceland, Norway and Liechtenstein, are only covered in the regional aggregate “Rest of Annex I”. Nevertheless, model results should be useful to gain a first insight in economic effects of linking ETS. Potential linking partner countries like China, Mexico, South Korea and Turkey are all included as separate regions, which makes the model in total very useful for an analysis of linking effects.

Dynamic efficiency and technological progress

PACE does not deal explicitly with dynamic efficiency. Regarding technological progress, only exogenous technological change, i.e. autonomous energy efficiency improvement (AEEI) is included, which shifts the production possibility frontier outside. Learning curves are not used. The AEEI parameter is derived from the Global Trade Analysis Project (GTAP) database. It is regularly updated as soon as the GTAP database is updated.

Endogenous technological change is planned to be included by some point in 2017. CCS is not yet included but it is planned to be by the end of 2016.

Figure 6: PACE model structure

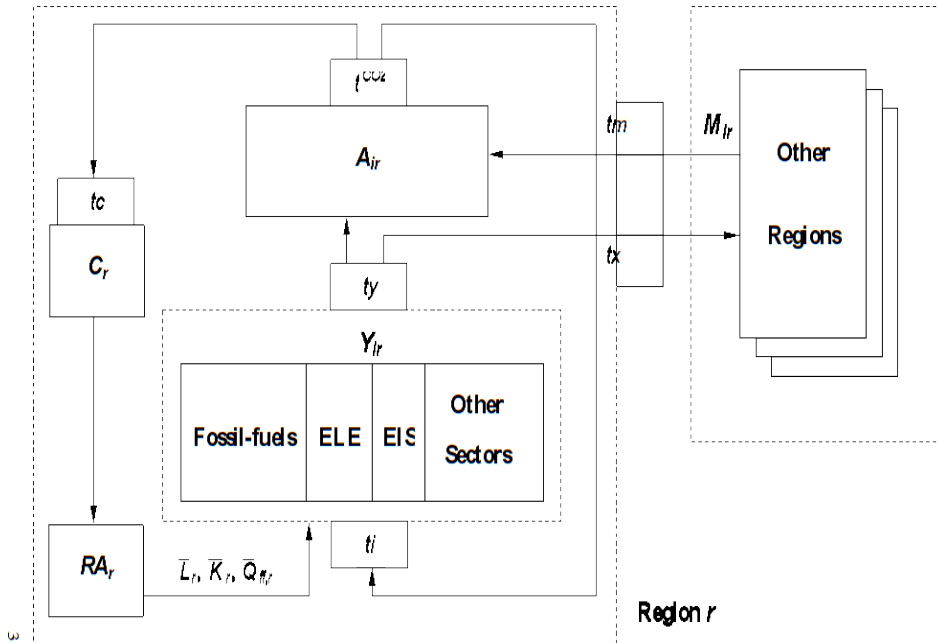

Source: Böhringer et al. 2009, p.1-3

- A_{ir} = Armington aggregate for demand category d of good i in region r
- C_r = Aggregate household consumption in region r
- M_{ir} = Aggregate imports of good i and region r
- RA_r = Representative agent in region r
- Y_{ir} = Production in sector i and region r
- ELE = Electricity
- EIS = Energy-intensive sectors
- L_r = Aggregate labor endowment for region r
- K_r = Aggregate capital endowment for region r Endowment
- Q_{ir} = Endowment of natural resource i for region r ($i \in \text{FF}$ (subset of fossil fuels))
- tc = Consumption taxes
- t^{CO_2} = Carbon tax
- ti = Intermediate taxes
- ty = Production taxes/subsidies
- tm = Import tariffs
- tx = Export tariffs

5.4 POLES

Table 8: Summary POLES

Model	Prospective Outlook on Long-term Energy Systems (POLES)
Author	LEPII-CNRS, Enerdata
Type	Partial equilibrium (Energy markets)
Time horizon of agents	Myopic optimisation, recursive dynamic
Time horizon of the model	Long-term: 1990-2050/2100 (1990-2010: period set by data and used for calibration), annual time steps
Economic Fields	(Domestic economy), linked permit market
Sectors	22 energy demand sectors (of which 4 industry sectors: Steel, Chemistry, Non-metallic minerals and Other industry), 1 agriculture, aviation
Regions	<p>Global: 57 full energy balances (7 regions, 11 sub-regions, 32 countries); 80 fossil fuel supply regions</p> <p><i>Region (sub-region) (country):</i></p> <ul style="list-style-type: none"> - North America (-) (United States; Canada) - Europe (EU-15; EU-25; EU-27) (Austria; Belgium; Denmark; Finland; France; Germany; Greece; Ireland; Italy; Netherlands; Portugal; Spain; Sweden; UK; Turkey; Bulgaria; Czech Republic; Hungary; Poland; Romania; Slovak Republic) - Japan-South Pacific (South Pacific) (Japan; Australia + New Zealand) - CIS (-) (Russia; Ukraine) - Latin America (Central America; South America) (Brazil; Mexico) - Asia (South Asia; South-East Asia) (India; South Korea; China) - Africa/Middle East (North Africa; Sub-Saharan Africa; Middle-East) (Egypt)
Emissions	CO ₂ , CH ₄ , N ₂ O, HFCs, CFCs, SF ₆ , PFCs; from fossil fuel combustion and energy use; reporting not sure whether by region or sector
Main databases	<p>ENERDATA, updated annually, take information from:</p> <ul style="list-style-type: none"> - Population growth: UN World Population Prospects - GDP growth: latest IMF forecasts (for the short run), MIT and CEPII forecasts (for the longer run) - Energy demand; energy prices: Eurostat, IEA, Enerdata - Industry sector energy use: Enerdata, Eurostat, IEA, IISI, World Bank - GHG emissions (+MACC?): UNFCCC GHG inventories, IPCC Assessment Reports, EDGAR database, IEA, EIA. - ENDOW (LEPII-EPE) (Emission quota endowments per sector database) organises all relevant information on national emission targets and sectoral National Allocation Plans, with particular detail for those countries under the EU ETS - Technologies: TECHPOL (more than 300 time-series on 30 technologies, 5 main economic performance parameters)

Wuppertal Institut, 2017, own compilation

POLES (Prospective Outlook on Long-term Energy Systems) is a global partial equilibrium model, developed to analyse energy markets and energy-related GHG mitigation policies. The model connects

three levels of analysis: international energy trade, regional energy balances and national/sectoral energy demand. It is solved by a year-by-year dynamic recursive modelling until the year 2100 with lagged adjustments of energy supply and demand by world region (Kitous et al. 2010, p.79). It can hence be used to analyse short- and long-term effects of linking ETS.

Data is yearly updated to capture recent developments in energy markets in different regions. The parameters, especially price and activity elasticities, were calibrated in previous studies with the model. Further parameters are estimated by the model, based on historical data (Kitous et al. 2010, p.80).

By definition, the partial equilibrium model does not cover the entire domestic economy, but focuses on domestic and global energy markets. As such, the overall economic activity (GDP) is exogenous, which is a main limitation. Further, international trade in non-energy goods is neither simulated. Still, linked permit markets can be modelled.

Permit market

Emission permit trade is included in the model, and can be analysed in more detail via the ASPEN-module (Analyse des Systèmes de Permis d'Emission Négociable) (LEPII-EPE & Enerdata 2009, p.3; LEPII-EPE & Enerdata 2006, p.55f.).

The ASPEN module was developed to simulate development of the EU-ETS carbon price. Endogenous marginal abatement cost curves are used to determine emission permit flows (endogenous permit imports and exports by country) and the equilibrium permit price, which is assumed to be equivalent to a shadow carbon tax (Criqui & Mima 2001, p.2,4). Hence, the model could be used to analyse the effects of linking on the equilibrium permit price, and on net capital flows between the linking partners.

The permit trade volume, a proxy for permit market liquidity, can be analysed by aid of several output variables: endogenous global or (linked) ETS-wide permit supply; endogenous global or (linked) ETS-wide permit demand; endogenous imports and exports of permits by country (LEPII-EPE & Enerdata 2006, p.53).

Further, ASPEN can be used to compare marginal and total abatement costs with and without a permit system, and to evaluate the gains from trade for different market structures (Criqui & Mima 2001, p.2). For the European Union, the model provides estimates of ETS- versus non-ETS splits. One can specify different trading rules and emission quota endowments (via the ENDOW-database for the EU-ETS) (LEPII-EPE & Enerdata 2006, p.55ff., 58ff.). Like it is common to most models, an exogenous emission constraint is a necessary model input.

Domestic economy

In contrast to most partial equilibrium models, POLES provides endogenous information about economic activity at the sectoral level, i.e. sectoral value added. This is important to assess the effects of linking ETS on competitiveness and carbon leakage. Aviation is covered explicitly. Yet, POLES, only differentiates 4 industry sectors in a total of 22 energy demand sectors (Steel, Chemistry, Non-metallic minerals and Other industry), which is too aggregated for meaningful carbon leakage and competitiveness analysis for the ETS-sectors in linked permit markets.

The model provides an endogenous simulation of full annual energy balances for a wide range of regions and international energy commodity trade. It simulates all steps of the energy system by sector and energy vector, including energy demand, primary energy supply and energy transformation. Investments in the energy sector are modelled endogenously (but not for the rest of the economy) (Kitous 2006, p.28).

International, regional and sectoral energy prices are endogenous. Yet, the model does not capture market power such as the influence of OPEC on the oil (and hence indirectly the natural gas) price

(Hedenus et al. 2012, p.27). Energy demand is determined by economic growth, autonomous technological change as well as short- and long-term demand elasticities (Hedenus et al. 2012, p.28). Agents decide about the investments and the utilisation rate, with a myopic anticipation of future costs and constraints, considering resource potentials, vintage and other inertia (Hedenus et al. 2012, p.27). Hence, unfortunately, the model does not use the more realistic limited foresight as major driving force for investments.

Regional coverage

With more than 57 full energy balances, the regional coverage of POLES provides flexibility in the level or regional aggregation. This relatively detailed global coverage is a good starting point for the analysis of carbon leakage and competitiveness-effects for linked ETS sectors with regard to the linking partner, third countries or the rest of the world. The EU-27 can serve as a proxy for the EU-ETS-31, since only the relatively small countries Liechtenstein, Iceland and Norway would lack this aggregate. Some major economies that have already introduced an ETS or are considering to do so later (e.g. China, Mexico, South Korea, Turkey) are covered at the individual country-level.

Dynamic efficiency and technological progress

Since technological change is exogenous in the model, the endogenous simulation of dynamic efficiency is not possible.

Figure 7: POLES model structure

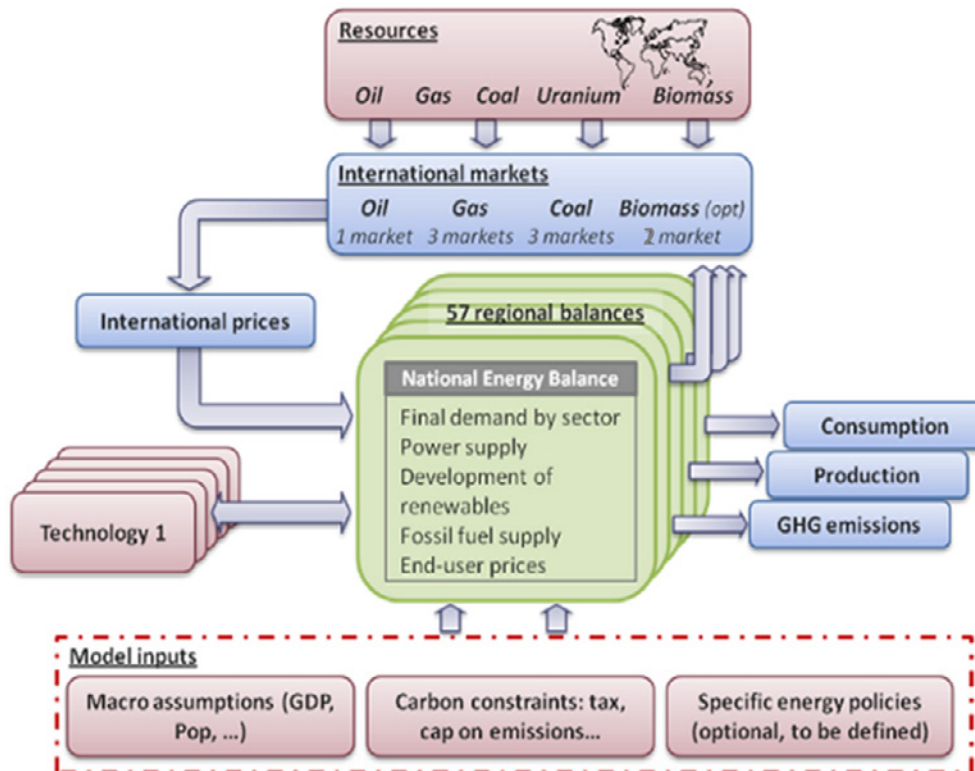

Note: The Red boxes are the main assumptions, calibration and scenario settings; the Green box represents the energy balance resolution by country / region and the Blue boxes represent the trade and key outputs (demand, supply, emissions).

Source: <https://wiki.ucl.ac.uk/display/ADVIAM/Model+concept%2C+solver+and+details+-+POLES>

5.5 TIMES

Table 9: Summary TIMES

Model	The Integrated MARKAL-EFOM System (TIMES) (MARKAL = MARKET ALlocation; EFOM = Energy Flow Optimisation Model)
Author	International Energy Agency (IEA)/ Energy Technology Systems Analysis Program (ETSAP)
Type	Partial equilibrium (Energy markets); TIMES-MACRO: combine TIMES with one-sectoral CGE model
Time horizon of the agents	Default: Perfect foresight optimisation, but limited foresight, myopic and stochastic options are available
Time horizon of the model	TIMES: Flexible (evolution over a period of usually 20 to 50 or 100 years, with flexible time steps and different time-slices for each annual variable month to hour; can have time slices of different lengths, too (eg. short in short-run, longer in long-run)) ETSAP-TIAM: 2005-2100 (2005 is IEA data base year) with 1-year time steps
Economic fields	(Domestic economy), permit market
Sectors	TIMES: Flexible (as many as desired energy producers & energy consumers) NOTE: Only energy producers have endogenous values Times Integrated Assessment Model (TIAM): 42 primary energy resources in 13 forms, large energy sector representation (up to 1000 technologies energy conversion), energy demand sectors: 6 industry sectors, 1 agriculture, no explicit forestry, aviation TIMES-MACRO: + 1 macro-sector
Regions	TIMES: Flexible: Up to 27 regions at the global, multi-regional, national, province or community level (Some TIMES modules cover up to 30 regions) ETSAP-TIAM: Global: 15 regions - Africa - Australia + New Zealand - Canada - Central and South America - China - EU - Central Asia Caucasus - Other Eastern Europe - Russia - India - Japan - Mexico - Middle East (incl. Turkey) - Other developing Asia - South Korea - USA
Emissions	CO ₂ from energy consumption (including process emissions into the model is possible), CH ₄ , N ₂ O from energy consumption and adipic and nitric acid industries, no PFCs

Model	The Integrated MARKAL-EFOM System (TIMES) (MARKAL = MARKET ALlocation; EFOM = Energy Flow Optimisation Model)
Main databases	<p>TIMES: Own data collection required, unless the user has access to an existing model. Yet, publicly available data sources are abundant (see below). ETSAP starter model contains a limited technology database (“base-dataset”) from documented data sources.</p> <ul style="list-style-type: none"> - Energy data base year calibration: IEA Extended Energy Balances of OECD and non-OECD countries - Population: UN estimations - GDP: Figures for future economic growth are based on an assumption of economic convergence between regions; alternatively GEM-E3 model inputs, e.g. set of coherent growth rates - International and region-specific data (installed capacities and resource potentials) form various sources: IEA-ETP, USDOE, USEPA, USGS, EGRID, NRCAN, WEC, World Energy council, IPCC-TAR, US Geological Survey etc.) - Technology characteristics: based on literature or expert knowledge (IPCC reports, US-Environmental Protection Agency, IEA-Energy Technology Perspectives, US-Department of Energy, US Geological Survey, World Energy Council, etc.) <p>TIAM: includes a large technology database, but sources are not well documented</p>

Wuppertal Institut, 2017, own compilation

TIMES(-MARKAL) is a partial equilibrium model family, developed by the IEA and maintained by the Energy Technology Systems Analysis Programme (ETSAP) (Loulou et al. 2005, p.22). The TIMES model generator was developed as a successor of the MARKAL energy model generator, and has some additional features like endogenous energy trade between the regions, stochastic programming with risk aversion and vintage of technologies (Loulou & Labriet 2008, p.8f.). The parameters in TIMES are calibrated by using data from the baseline period (Loulou & Labriet 2008, p.13+18ff.+29 for endogenisation of technological parameters+p.31f. for stochastic programming).

TIMES can be flexibly adapted to the users’ needs for analysing local, national or multi-regional energy systems or specific energy sectors. The ETSAP-TIAM (ETSAP-Times Integrated Assessment Model) is one of its widely-used multiregional specifications with a climate module extension.

The time horizon and steps in TIMES are flexible, which allows a detailed analysis of short- and long run effects of linking ETS. ETSAP-TIAM for example has a long time horizon (up to the year 2100), with 1-year time steps.

Usually, TIMES assumes competitive energy markets with perfect foresight. Yet, limited foresight over some periods can be chosen, and the stochastic programming function allows for uncertainty (Loulou & Labriet 2008, p.25f.). Running the model several times under stochastic programming might provide a range of potential results, which is especially useful in the context of volatile and uncertain future permit prices.

Since TIMES is a partial equilibrium model, the domestic economy and international trade in goods and services is only superficially simulated. The permit market is covered, since regions are linked via energy-, material- and, optionally, permit trading. As such, actions in one region affect the other regions (Loulou & Labriet 2008, p.16, 21f.). In its default-version, TIMES only reports GHG per region, sector and fuel from energy consumption (Loulou & Labriet 2008, p.12, 16), but according to the modellers, constructing a TIMES-based model that accounts for emissions from production processes is

possible. TIMES-based models further are suited to model the real emissions of ETS-sectors, in addition to their exogenously given ETS-market-cap.

Permit market

Via the ETS constraint and the permit market, TIMES-based models provide endogenous emission shadow prices and permit prices (Loulou & Labriet 2008, p.1, 16, 24). It is possible to run any TIMES-based model with a cap on selected ETS-sectors – there is no need for an economy-wide emission cap to calculate the shadow prices and the permit prices. The user has full control over which emissions matter for calculating the permit price. The resulting endogenous MAC give the MACC when plotted against different abatement levels. However, according to the modellers, such a curve would never be unique, because the assumed emission targets for other model years will of course affect the marginal abatement costs in any single year.

Overall, TIMES is in parts useful to model the impacts of linking. Albeit there is no trade in manufactured goods in TIMES, permit trade can be optionally included (e.g. in TIAM-UCL) in addition to trade in raw materials/commodities (Loulou & Labriet 2008, p.21). Net capital flows from permit buyer to permit seller are not explicitly modelled. Yet, one can alternatively multiply the amount of permit trade with the simulated permit price to obtain the value of total capital flows.

Since international permit trade is modelled, one obtains the overall trading volume, which is used as a proxy for assessing permit market liquidity. However, the model assumes perfect competition and perfect markets as well in the permit market. Therefore, the usefulness of the results for assessing the impacts of linking accounting for market imperfections is limited (Loulou & Labriet 2008, p.21). One can however simulate some market imperfections by adding transaction costs in the model. Permit banking can be modelled via inter-period storage.

TIMES-based models are not capable of calculating the number and size of market participants in the permit market, to estimate market power or to calculate the number of trades in the permit market.

Domestic economy

GDP is exogenous in TIMES (Loulou & Labriet 2008, p.10). The TIMES-MACRO version links TIMES to a one-sectoral CGE model (Loulou et al. 2005, p.22; Remme & Blesl 2006). This might be useful to simulate overall economic performance, i.e. to obtain endogenous GDP values. Yet, a one-sectoral model is not disaggregated enough for analysing the effects of linking on competitiveness and carbon leakage.

Regarding overall sectoral coverage, the amount of included energy producer and consumer sectors and the level of sectoral disaggregation is flexible in TIMES, as long as data is available. TIMES-based models however do not report any endogenous production by sector, i.e. in terms of gross value added (GVA). Instead, endogenous changes in relative production costs can serve as an alternative proxy to analyse competitiveness-effects of linking. Alternatively, one could use output from GEMINI-E3 to obtain “endogenised” values for industrial production (Loulou & Labriet 2008, p.10). Endogenous investments are only simulated for the energy sector (Loulou & Labriet 2008, p.21).

The energy sector in ETSAP-TIAM is characterised by a very high level of technological detail: Several thousand technologies in all sectors of the energy system can be chosen for each region (Loulou & Labriet 2008, p.21). Yet, within the group of energy demand sectors, the model disaggregated only 6 industry sectors, which is too aggregated for competitiveness and carbon leakage analyses for the ETS-sectors.

In ETSAP-TIAM, energy demand is influenced by prices while, at the same time, it affects the prices. The supply of energy services is subject to resource and policy constraints and a set of exogenous technological specifications. The model finds the cost-minimising solution by simultaneously making decisions on energy supply, trade and technology investments. Markets are in equilibrium in each time period.

Since TIAM-models are partial equilibrium models, macroeconomic competitiveness-effects between regions are not included. Technology competitiveness effects are automatically included whenever multiple competing technology alternatives available in the model.

Regional coverage

The regional coverage in TIMES is as well flexible. Up to 27 regions at the global, multi-regional, national, province or community level can be included. It is important to choose a global coverage for the analysis of carbon leakage and competitiveness-effects for linked ETS sectors with regard to third countries and the linking partner.

Regional coverage in ETSAP-TIAM does fulfil the requirements of the present analysis to large extend. The EU can be taken as a proxy for the EU-ETS-31. China, South Korea and Mexico are included as individual countries. Turkey cannot be analysed with the ETSAP-TIAM specification, since it is part of the "Middle East" regional aggregate.

Dynamic efficiency and technological progress

In a bottom-up model like TIMES, (energy) efficiency is modelled explicitly at the technology level. The assumptions are defined directly in terms of process efficiencies, and efficiency losses due to partial loads. Yet, TIMES does not prescribe any assumptions regarding technology usage and technological change. It is fully up to the user to specify the assumptions on technological development, technology usage and associated technological costs. Therefore, it is as well up to identify relevant data sources and to gather the required data for simulating (low-carbon) technology usage, technological costs and technological change.

Technological change is usually defined by exogenous learning curves for new technology vintages (= decreasing costs, improving efficiencies and capacity factors), and constraints on learning as a function of cumulative past investments. Endogenous (non-convex) learning can be modelled by using the ETL option. Since there is no explicit production function, nor MACCs in TIMES, the technology parameters for each vintage are directly reflected in the physical results and cost accounting. The production function for each sector is constructed implicitly.

Macro-economic dynamic efficiency is not dealt with in TIMES. In a bottom-up model like TIMES, dynamic efficiencies are modelled explicitly at the technology level. The efficiency of any technology can be defined to be dependent of technology vintage (efficiency varying by vintage 2010, 2015, 2020, 2025,...) the age of the installation (efficiency varying by age of 1,2,3,... years), the operating timeslice (efficiency varying by season, or by time of day), or the operating level (efficiency varying according to load levels 10%–100%).

Efficiency improvements due to increased labour productivity can be taken into account in labour costs (operating costs), but the labour market is not represented.

Latest update

The latest version of TIME is from September 2016. Data updates need to be done by the users individually, depending on which data sources they use.

Figure 8: TIMES model structure

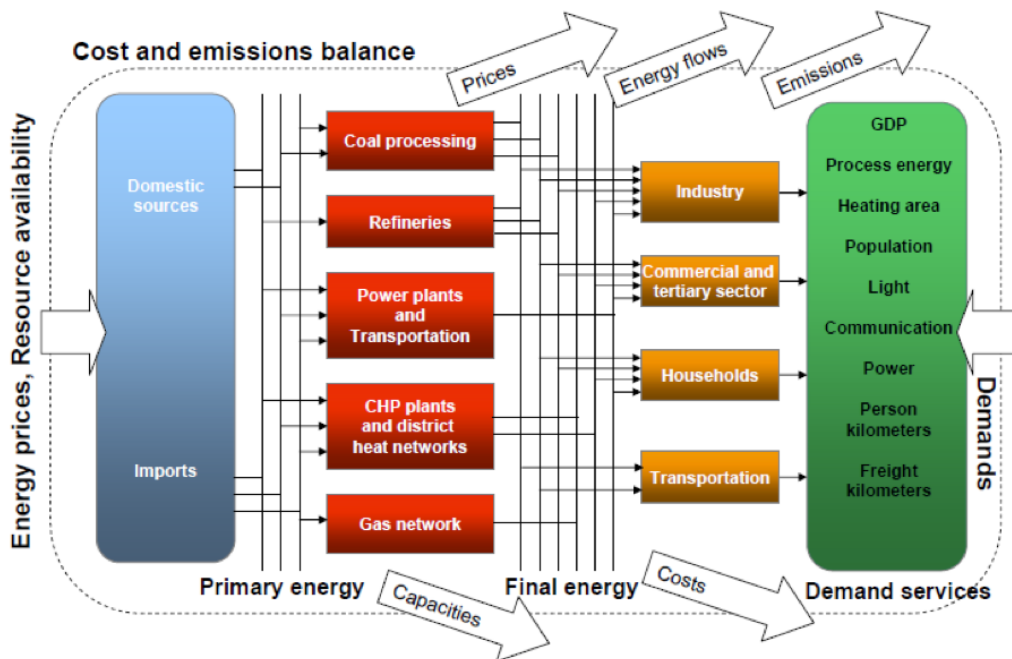

Source: <http://www.iea-etsap.org/web/Times.asp>

5.6 Overview-table over the fulfilment of criteria by model

Table 10: Overview over the fulfilment of criteria by model

Model	E3ME	GEM-E3	PACE	POLES	TIMES
Type					
Time horizon of agents					
Economic fields					
Sectors					
Regions					
Time horizon of the model					
Emissions					

6 Bibliography

- Alexeeva-Talebi, V., 2009. Modelling environmental dimension, policy analysis and the assessment of the model reliability. *Presentation at the Kickoff-meeting for the Sust-Rus Project*.
- Alexeeva-Talebi, V. et al., 2012. The Value-Added of Sectoral Disaggregation: Implications on Competitive Consequences of Climate Change Policies. *Working Paper*.
- Alexeeva-Talebi, V. & Anger, N., 2007. Developing Supra-European Emissions Trading Schemes: An Efficiency and International Trade Analysis. *ZEW Discussion Paper No. 07-038, 07(038)*.
- Babiker, M. et al., 2008. MIT Joint Program on the Science and Policy of Global Change Emissions Prediction and Policy Analysis. *MIT Joint Program on the Science and Policy of Global Change Report, (125)*. Available at: <http://dspace.mit.edu/handle/1721.1/44618>.
- Bauer, N. et al., 2011. REMIND: The equations. *Potsdam Institute of Climate Impact Research Publication*.
- Beuermann, C., Bingler, Santikarn, Tänzler, Thema 2017:
- Böhringer, C. & Löschel, A., 2004. Policy Analysis based on Computable Equilibrium. *TranSust Model Comparisons*.
- Böhringer, C., Löschel, A. & Rutherford, T.F., 2009. PACE model description. *na*, p.27.
- Cambridge Econometrics, 2014. *E3ME Technical Manual, Version 6.0*,
- Capros, P. et al., 2013. *GEM-E3 Model Documentation*,
- Chen, Y.-H.H. et al., 2015. The MIT EPPA6 Model: Economic Growth, Energy Use, Emissions, and Food Consumptions. *MIT Joint Program on the Science and Policy of Global Change Report, (278)*.
- Criqui, P. & Mima, S., 2001. The EU Tradable Emission Permit System: some policy issues identified with the POLES-ASPEN model. *Energy Forum 1. Integrating the Kyoto Mechanisms into the National Framework Presentation Template*.
- E3M Lab, 2010. *GEM-E3 Model Manual*, Available at: <http://147.102.23.135/e3mlab/GEM-E3Manual/ManualofGEM-E3.pdf>.
- Fujimori, S., Masui, T. & Matsuoka, Y., 2012. AIM/CGE [basic] manual. *Center for Social and Environmental Systems Discussion Paper Series, 2012(01)*.
- Hedenus, F., Johansson, D. & Lindgren, K., 2012. A critical assessment of energy-economy-climate models. *Physical Resource Theory*, pp.1–31. Available at: http://publications.lib.chalmers.se/records/fulltext/local_154479.pdf.
- Kitous, A., 2006. *POLES Model. A World Energy Model*,
- Kitous, A. et al., 2010. Transformation patterns of the worldwide energy system - Scenarios for the century with the POLES model. *Energy Journal, 31(SPECIAL ISSUE)*, pp.49–82.
- LEPII-EPE & Enerdata, 2009. Energy Scenarios, Technology Development and Climate Policy Analysis with the POLES Modelling System.
- LEPII-EPE & Enerdata, 2006. Energy Scenarios, Technology Development and Climate Policy Analysis with the POLES Modelling System. , p.90.
- Loulou, R. et al., 2005. Documentation for the TIMES Model Part I. *IEA Energy Technology Systems Analysis Programme, (April)*, pp.1–78.
- Loulou, R. & Labriet, M., 2008. ETSAP-TIAM: The TIMES integrated assessment model Part I: Model structure. *Computational Management Science, 5(1-2)*, pp.7–40.
- Luderer, G. et al., 2013. Description of the REMIND model (Version 1.5). *Potsdam Institute of Climate Impact Research Publication*.
- McKibbin, W.J. & Wilcoxon, P.J., 2013. *A Global Approach to Energy and the Environment: The G-Cubed Model*, Available at: <http://dx.doi.org/10.1016/B978-0-444-59568-3.00015-8>.
- NTUA & E3M-Lab/ICSS, 2014. *PRIMES Model. Detailed model description*,

- Pezzey, J. & Lambie, R., 2001. CGE Models for Evaluating Domestic Greenhouse Policies in Australia: A Comparative Analysis. *Report to the Productivity Commission, AusInfo*, p.127. Available at: http://pc.gov.au/__data/assets/pdf_file/0019/61174/cgegreenhouse.pdf.
- Remme, U. & Blesl, M., 2006. Documentation of the TIMES-MACRO model. Draft version. *ETSAP Report*.
- Sassi, O. et al., 2010. IMACLIM-R: a modelling framework to simulate sustainable development pathways. *International Journal of Global Environmental Issues*, 10(1/2), pp.5–24.
- Umweltbundesamt (UBA) forthcoming: Final Report of research project FKZ 714 41 505 0
- Vabitsch, A.M., 2006. *Qualitativer Vergleich von Modellen zur Bewertung von Klimaschutzmaßnahmen in Europa unter besonderer Berücksichtigung der Landwirtschaft*,
- Waisman, H. et al., 2010. The IMACLIM-R Model: Infrastructures, Technical Inertia and the Costs of Low Carbon Futures under Imperfect Foresight. *CIREN Working Paper*.
- World Bank & Ecofys, 2014. State and Trends of Carbon Pricing 2014. *World Bank*.